



Draco **tera enterprise**

480 Series

KVM-Matrix Switch

User Manual

Edition: 2020-02-26

Firmware version 03.08



Copyright

© 2020. All rights reserved. This information may not be reproduced in any manner without the prior written consent of the manufacturer.

Information in this document is subject to change without notice.

Trademarks

All trademark and trade names mentioned in this document are acknowledged to be the property of their respective owners.

Disclaimer

While every precaution has been taken during preparation of this manual, the manufacturer assumes no liability for errors or omissions. The manufacturer assumes no liability for damages resulting from the use of the information contained herein.

The manufacturer reserves the right to change specifications, functions, or circuitry of the product without notice.

The manufacturer cannot accept liability for damage due to misuse of the product or due to any other circumstances outside the manufacturer's control (whether environmental or installation related). The manufacturer shall not be liable for any loss, damage, or injury arising directly, indirectly, incidentally, or consequently from the use of this product.

Contents

1	About This Manual	9
1.1	Scope.....	9
1.2	Validity	9
1.3	Cautions and Notes.....	9
1.4	Spellings	9
2	Safety Instructions	10
3	Description	11
3.1	Application	11
3.2	Access Options	11
3.3	System Overview	12
3.4	Product Range	13
3.5	Accessories.....	13
3.6	Device Views	15
3.6.1	Draco tera 576 Port.....	15
3.6.2	Draco tera 288 Port.....	17
3.6.3	Draco tera 160 Port.....	19
3.6.4	Draco tera 152 Port.....	20
3.6.5	Draco tera 80 Port.....	21
3.6.6	Draco tera 48 Port.....	22
3.7	Diagnostics and Status	23
3.7.1	Status LEDs.....	23
3.7.2	Port Status	31
3.7.3	Port Status Matrix Grid.....	35
3.7.4	Extender OSD.....	36
3.7.5	Network Status.....	37
3.7.6	Firmware Status Matrix	40
3.7.7	Firmware Status Extender.....	42
3.8	Trace Function	43
3.9	Syslog Monitoring.....	44
3.10	SNMP.....	46

3.11	System Check.....	50
3.12	Device Finder.....	51
4	Installation	53
4.1	Package Contents.....	53
4.2	System Setup.....	53
4.3	Example Applications.....	54
4.3.1	KVM Matrix	55
4.3.2	Video Matrix.....	56
4.3.3	Parallel Operation (Stacking)	57
4.3.4	Matrix Grid	59
5	Configuration.....	61
5.1	Command Mode.....	61
5.2	Control Options	63
5.2.1	Control via OSD	63
5.2.2	Control via Java Tool	68
5.2.3	Control via Serial Interface.....	77
5.3	Assignment	77
5.3.1	Virtual CPU	77
5.3.2	Virtual Console.....	80
5.4	System Settings	83
5.4.1	System Data	83
5.4.2	Automatic ID	88
5.4.3	Access	91
5.4.4	Switch	95
5.4.5	Network.....	99
5.4.6	Date and Time	104
5.5	User Settings	107
5.5.1	User	107
5.5.2	Favorite List Users	110
5.5.3	User Macros.....	113
5.5.4	User Groups.....	117
5.6	Extender Settings.....	119

5.6.1	Flex-Port Extender Units	121
5.7	USB-2.0-Extender	122
5.8	Extenders for UNI I/O Boards (USB 2.0 / USB 3.0).....	125
5.9	Configuration of SDI.....	129
5.10	CPU Settings	132
5.11	CPU Groups.....	137
5.12	Configuration CPU Switch (484 Series)	139
5.13	Console Settings.....	140
5.13.1	CON Devices	140
5.13.2	Mouse and Keyboard	146
5.13.3	Extender OSD.....	149
5.13.4	Favorite List Consoles.....	152
5.13.5	Console Macros	154
5.13.6	Shared Operation.....	158
5.13.7	Multi-Screen Control	161
5.13.8	Active Directory	166
5.14	Saving and Loading of Configurations	170
5.14.1	Active Configuration.....	170
5.14.2	Saving of Configurations (internal).....	171
5.14.3	Loading of Configurations (internal)	174
5.14.4	Saving of Configurations (external).....	176
5.14.5	Loading of Configurations (external)	177
5.15	Export and Import Options	178
5.15.1	Export Options	178
5.15.2	Import Options	179
5.16	Matrix Cascading	180
5.17	Matrix Grid	185
5.18	USB-HID Ghosting.....	190
5.19	Management of DDC Information (EDID).....	192
5.20	Firmware Update.....	195
5.20.1	Matrix Update.....	195
5.20.2	Extender Update	197

5.21	License Management.....	202
6	Operation	203
6.1	Operation via 'Hot Keys'.....	204
6.1.1	Direct Switching	204
6.1.2	Scan Mode.....	206
6.1.3	Function Keys <F1>-<F16>.....	206
6.1.4	Addressing of Master and Sub Matrices	207
6.2	KVM-Switching.....	208
6.3	Extended Switching.....	211
6.4	Switching via Macro List.....	216
6.5	Switching of single Extenders within Devices	218
6.6	CON Switch	219
6.7	Multi-Screen Control	221
6.8	USB 2.0 Switching	222
6.9	Presets.....	223
6.10	Tera View.....	224
6.11	Redundancy Function	227
6.12	Serial Interface.....	230
6.13	Power On and Power Down Functions	231
6.13.1	Restart	231
6.13.2	Factory Reset.....	232
6.13.3	Power Down.....	232
6.14	Summary of Keyboard Commands	233
7	Specifications	235
7.1	Interfaces	235
7.1.1	DVI-D Single Link.....	235
7.1.2	USB-HID	235
7.1.3	RJ45 (Network)	236
7.1.4	RS-232 (Serial)	236
7.1.5	RJ45 (Interconnect)	236
7.1.6	Fiber SFP Type LC (Interconnect)	236
7.1.7	SDI (Interconnect).....	237

7.2	Interconnect Cable.....	237
7.2.1	Cat X.....	237
7.2.2	Fiber.....	238
7.2.3	Coaxial.....	239
7.3	Connector Pinouts.....	240
7.3.1	CPU Board.....	240
7.3.2	I/O Port Cat X.....	241
7.3.3	I/O Port SFP.....	242
7.3.4	I/O Port SDI.....	242
7.4	Power Supply.....	242
7.5	Environmental Conditions.....	243
7.6	Size.....	244
7.7	Shipping Weight.....	245
7.8	MTBF.....	246
8	Maintenance.....	247
8.1	Power Supply Units.....	247
8.2	Fan trays.....	247
8.3	CPU Board.....	248
8.4	I/O-Board.....	248
8.5	Filter Pads.....	249
9	Troubleshooting.....	250
9.1	External Failure.....	250
9.2	Video Interference.....	250
9.3	Malfunction of Fans.....	250
9.4	Malfunction of Power Supply Units.....	251
9.5	Network Error.....	251
9.6	Failure at the Matrix.....	251
9.7	Blank Screen.....	252
10	Technical Support.....	253
10.1	Support Checklist.....	253
10.2	Shipping Checklist.....	253

11 Certificates/Directives..... 254

11.1 North American Regulatory Compliance 254

11.2 Product Safety 254

11.3 WEEE 255

11.4 RoHS 255

12 EU Declaration of Conformity 256

13 Glossary 257

13.1 Matrix specific Glossary 260

1 About This Manual

1.1 Scope

This manual describes how to install your Draco tera, how to operate it and how to perform trouble shooting.

1.2 Validity

This manual is valid for all devices listed on the front page. The product code is printed on the base of the devices.

1.3 Cautions and Notes

The following symbols are used in this manual:



This symbol indicates an important operating instruction that should be followed to avoid any potential damage to hardware or property, loss of data, or personal injury.



This symbol indicates important information to help you make the best use of this product.



This symbol indicates best practice information to show recommended and optimal ways to use this product in an efficient way.

1.4 Spellings

The following spellings are used in the manual:

Spelling	Description
<key>	Description of a key on the keyboard
<key> + <key>	Press keys simultaneously
<key>, <key>	Press keys successively
2x <key>	Press key 2x in quick succession (cf. mouse double click)
Menu item	Description of a menu item in the software
Menu item > Menu item	Select menu items successively
Bold print	Description of terms that are used in the device software

2 Safety Instructions

To ensure reliable and safe long-term operation of your Draco tera please note the following guidelines:

Installation

- Only use the device according to this User Manual. Failure to follow these procedures could result in damage to the equipment or injury to the user or installer.
- Only use in dry, indoor environments.
- The Draco tera and the power supply units can get warm. Do not install components in an enclosed space without any airflow.
- Do not obscure ventilation holes.
- Only use power supplies originally supplied with the product or manufacturer-approved replacements. Do not use a power supply if it appears to be defective or has a damaged chassis.
- Connect all power supplies to grounded outlets. In each case, ensure that the ground connection is maintained from the outlet socket through to the power supply's AC power input.
- In case the device is equipped with one or more grounding screws, it is obligatory to use these for normal operation in order to ensure the grounding of the chassis.
- Do not connect the link interface to any other equipment, particularly network or telecommunications equipment.
- Only connect devices to the serial interface that are protected against short circuit currents and incorrect voltages at the serial interface.
- To disconnect the Draco tera from the power supply, remove the power cord cables of all power supply units or switch supplies off.
- Take any required ESD precautions.



In order to disconnect the device completely from the electric circuit, all power cables have to be removed.

Repair

- Do not attempt to open or repair a power supply unit.
- Do not attempt to open or repair the Draco tera. There are no user serviceable parts inside.
- Please contact your dealer or manufacturer if there is a fault.

3 Description

3.1 Application

The Draco tera matrix is used to establish connections from consoles (monitor, keyboard, mouse, and other peripheral devices) to various sources (computer, CPU).

In its maximum configuration, up to 576 independent ports can be defined and switched either as a console or a CPU.

The Draco tera matrix is designed to operate with extenders that are able to transmit video, KVM and USB 2.0 signals. But it can also be used as a video matrix.

The connection between the matrix and the peripheral devices, such as KVM extenders or video sources, can be made by Cat X, fiber or coaxial cables.

The matrix serves as a repeater and can be run at a maximum distance of 10 km from the consoles and 10 km from the sources.





This is a Class A product. In a domestic environment, this product may cause radio interference in which case the user may be required to take adequate measures.

The safety instructions and installation guidelines noted in this manual shall be considered in detail. Compliance with the specifications for cable lengths and types is mandatory.

3.2 Access Options

The following options are available to configure and operate the Draco tera:

Access Option	Symbol
OSD	
Java Tool	
Serial interface	

3.3 System Overview

A Draco tera matrix system consists of a Draco tera matrix and, for KVM applications, one or more CPU Units / CON Units. The Draco tera matrix is connected to the CPU Units / CON Units by interconnect cables or directly to the video devices where used as a video matrix.

CPU Units are connected directly to the sources (computer, CPU) by the provided cables.

Monitor(s), keyboard and mouse are connected to the CON Units.

Communication between the Draco tera matrix and the CPU Units / CON Units occurs over the respective interconnect cables.

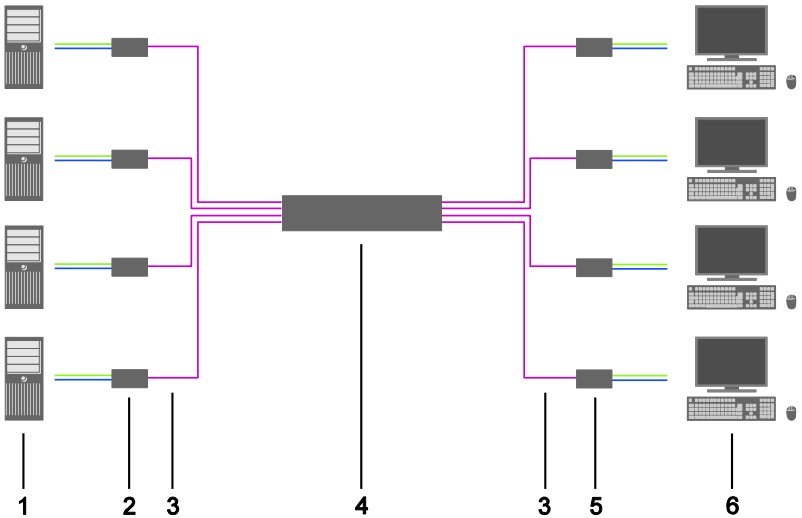

System Overview (exemplary)

- 1 Source (computer, CPU)
- 2 CPU Units
- 3 Interconnect cable
- 4 Draco tera matrix
- 5 CON Units
- 6 Console (monitor, keyboard, mouse)



See Chapter 4.3, Page 54 for installation examples.

3.4 Product Range

Part No.	Description
K480-576	Draco tera matrix with 576 ports, empty, free configuration
K480-576S	Draco tera matrix with 576 ports (288x288), empty, free configuration
K480-288	Draco tera matrix with 288 ports, empty, free configuration, preparation for redundant CPU board
K480-160	Draco tera matrix with 160 ports, empty, free configuration
K480-152	Draco tera matrix with 152 ports, empty, free configuration, preparation for redundant CPU board
K480-080	Draco tera matrix with 80 ports, empty, free configuration, preparation for redundant CPU board
K480-048	Draco tera matrix with 48 ports, empty, free configuration, preparation for redundant CPU board

3.5 Accessories

Part No.	Description
480-C8R1	Draco tera Cat X I/O board, revision 1
480-S8R1	Draco tera fiber I/O board, Single-mode, revision 1
480-C8X	Draco tera Cat X, 3.125 Gbit/s (XV)
480-S8X	Draco tera fiber I/O board, Single-mode, 3,125 Gbit/s (XV), revision 1
480-UNI16	Draco tera UNI I/O board for USB 3.0 and SDI
480-GRD-S8-R1	Draco tera 8 to 1 port Matrix Grid board (grid lines), Single-mode, 1.4 km
480-CTRL	Draco tera CPU board version 1
480-CTRL2	Draco tera CPU board version 2
480-C8BDG	Draco tera Cat X I/O board for the conversion of 1G to 3G (XV) signals (CPU Units only)
480-S8BDG	Draco tera fiber I/O Single-mode for the conversion of 1G to 3G (XV) signals (CPU Units only)
436-IECLOCK-EU	IEC connection cable for power supply, lockable, EU power connector

Part No.	Description
436-IECLOCK-US	IEC connection cable for power supply, lockable, US power connector
459-1C	Cat X GBIC for use with Draco tera
459-1S	Single-mode GBIC, LC duplex, bidirectional, for use with Draco minor / major / tera
459-1V	Single-mode GBIC, LC duplex, bidirectional, for use with Draco tera (3.125 Gbit/s)
459-6M	Multi-mode GBIC, LC duplex, bidirectional, USB 3.0 (6.25 Gbit/s), for use with Draco tera
459-10S10	Single-mode GBIC, LC duplex, bidirectional, for the use in Matrix Grid I/O boards (10 Gbit/s), distance 10 km
459-3BX	Coaxial GBIC, bidirectional, for the use with Draco tera (3G-SDI)
459-3DX	DIN 1.0/2.3 GBIC, bidirectional, for the use with Draco tera (3G-SDI)
459-3FX	Single-mode GBIC, LC duplex, bidirectional, for the use with Draco tera (3G-SDI)
459-BMB	Adapter cable BNC to HD-BNC to adapt regular BNC cables to HD-BNC SFPs
480-FAN576	Draco tera 576 fan tray (spare part)
480-FAN160	Draco tera 288/160/152 fan tray (spare part)
480-FAN80	Draco tera 80 fan tray (spare part)
480-FAN48	Draco tera 48 fan tray (spare part)
480-RED576	Draco tera 576 plug-in power supply unit (spare part or redundancy)
480-RED288	Draco tera 288 plug-in power supply unit (spare part or redundancy)
480-RED160	Draco tera 160/152 plug-in power supply unit (spare part or redundancy)
480-RED80	Draco tera 80 plug-in power supply unit (spare part or redundancy)
480-FLTR576	Draco tera 576 filter pads as consumable supply
480-FLTR160	Draco tera 288/160/152 filter pads as consumable supply
480-FLTR80	Draco tera 80 filter pads as consumable supply
480-FLTR48	Draco tera 48 filter pads as consumable supply

3.6 Device Views

The following views of the Draco tera matrix illustrate the various available chassis types.

3.6.1 Draco tera 576 Port

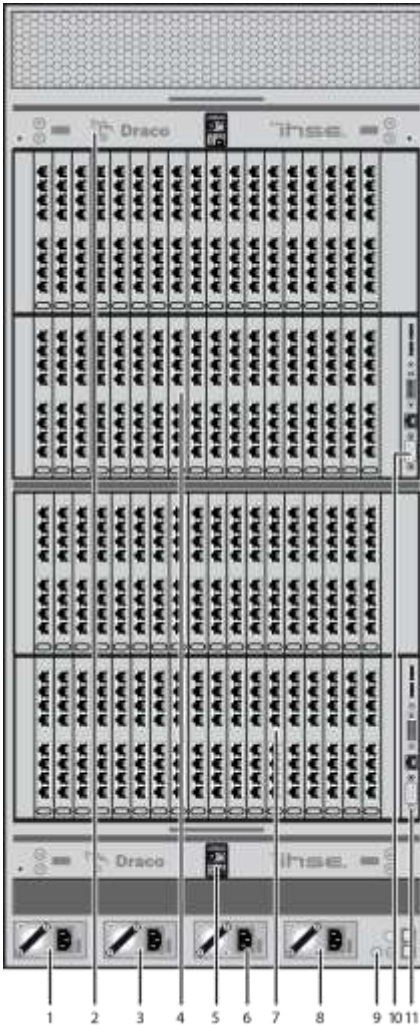

Front View

- 1 Slot for power supply unit 1
- 2 Slot for fan tray 1
- 3 Slot for power supply unit 2
- 4 Slots for I/O boards #1–36
- 5 Slot for fan tray 2
- 6 Slot for power supply unit 3
- 7 Slots for I/O boards #37–72
- 8 Slot for power supply unit 4
- 9 Grounding
- 10 Slot for CPU board 1
- 11 Slot for CPU board 2

3.6.2 Draco tera 288 Port

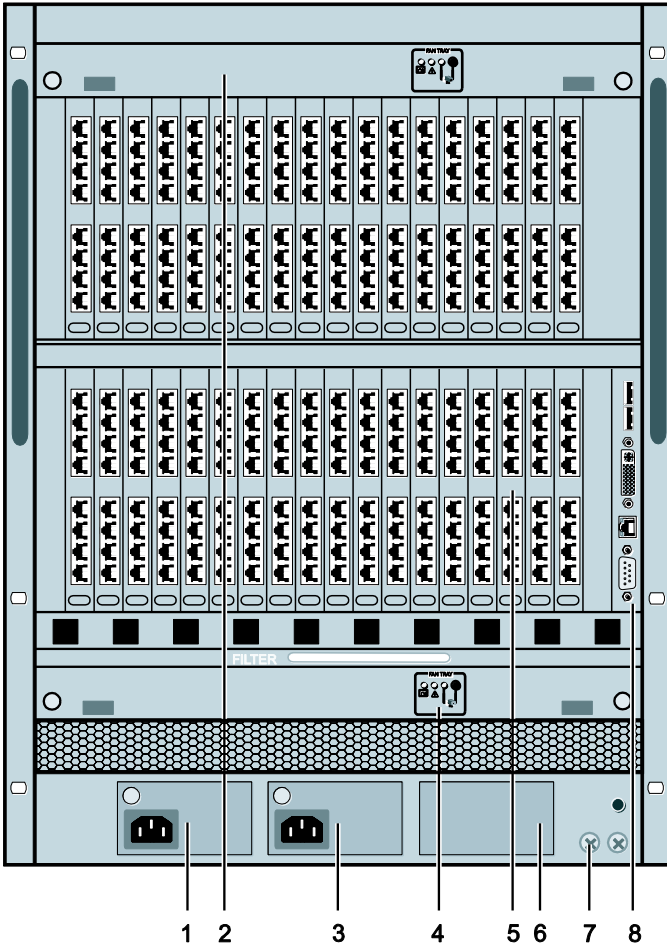

Front View

- 1 Slot for power supply unit 1
- 2 Slot for fan tray 1
- 3 Slot for power supply unit 2
- 4 Slot for fan tray 2
- 5 Slots for I/O boards #1–36
- 6 Slot for power supply unit 3
- 7 Grounding
- 8 Slot for CPU board

3.6.3 Draco tera 160 Port

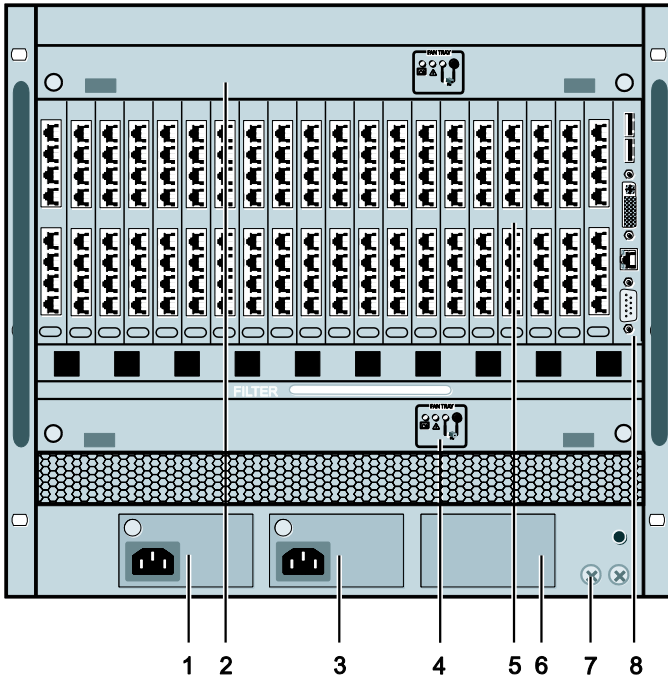

Front View

- 1 Slot for power supply unit 1
- 2 Slot for fan tray 1
- 3 Slot for power supply unit 2
- 4 Slot for fan tray 2
- 5 Slots for I/O boards #1–20
- 6 Slot for power supply unit 3
- 7 Grounding
- 8 Slot for CPU board

3.6.4 Draco tera 152 Port

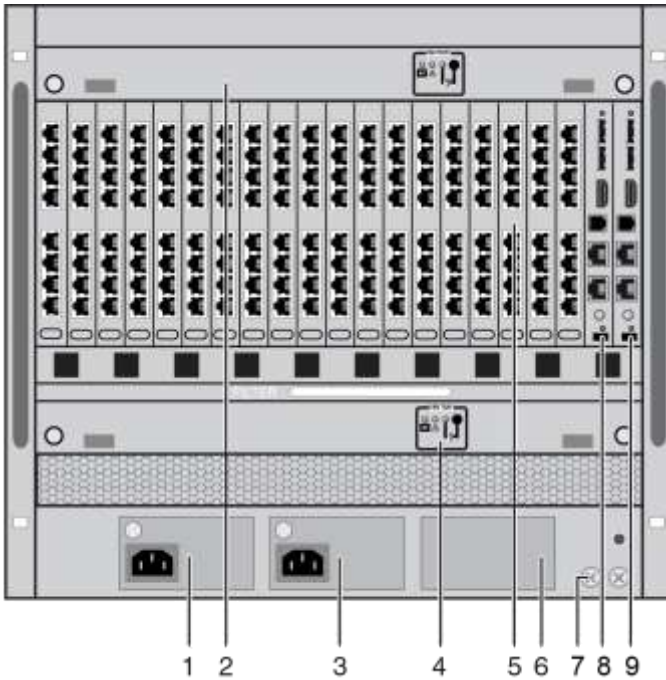

Front View

- 1 Slot for power supply unit 1
- 2 Slot for fan tray 1
- 3 Slot for power supply unit 2
- 4 Slot for fan tray 2
- 5 Slots for I/O boards #1–20
- 6 Slot for power supply unit 3
- 7 Grounding
- 8 Slot for CPU board (redundancy)
- 9 Slot for CPU board

3.6.5 Draco tera 80 Port

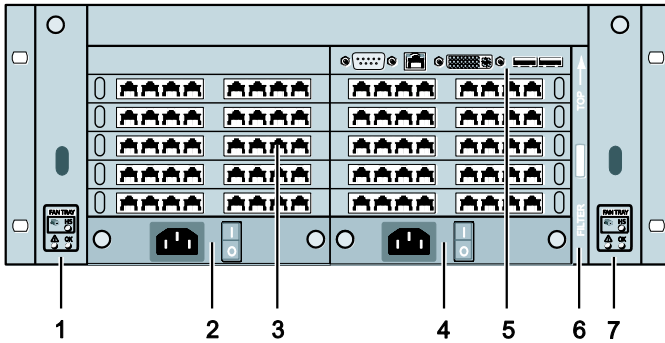

Front View

- 1 Slot for fan tray
- 2 Slot for power supply unit 1
- 3 Slots for I/O boards #1–10
- 4 Slot for power supply unit 2
- 5 Slot for CPU board
- 6 Slot for air filter
- 7 Slot for fan tray 2

3.6.6 Draco tera 48 Port

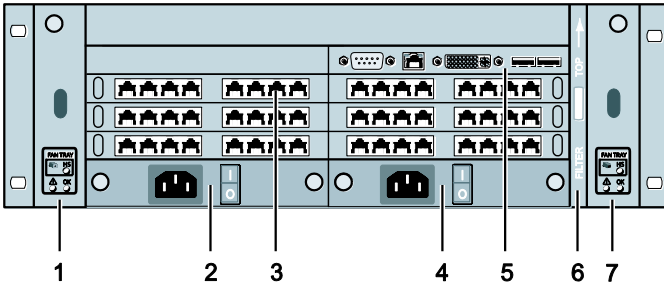

Front View

- 1 Slot for fan tray
- 2 Slot for power supply unit 1
- 3 Slots for I/O boards #1-6
- 4 Slot for power supply unit 2
- 5 Slot for CPU board
- 6 Slot for air filter
- 7 Slot for fan tray 2

3.7 Diagnostics and Status

3.7.1 Status LEDs

Draco tera components are fitted with the following LEDs for overall status indication:

CPU Board

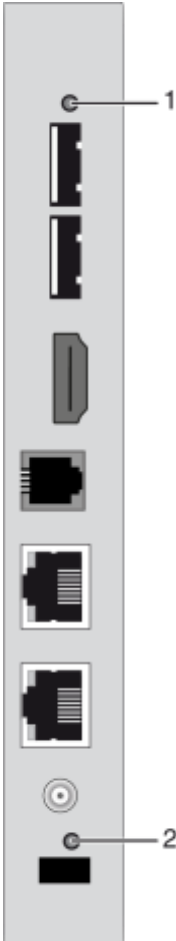

Front View

Status LEDs on CPU board:

Pos.	LED	Status	Description
1	Status 1	White	CPU board is in registration process
		Blue flashing	Registration of the matrix has started
		Red flashing	Registration in progress
		Green flashing	Operating condition
		Green	CPU board de-registered
2	Status 2	White	CPU board is in registration process
		Red flashing	Registration of the matrix has started
		Off	Operating condition



Due to variations in LED type "white" might also appear as light purple or light blue.

I/O Board

Cat X



SFP Fiber

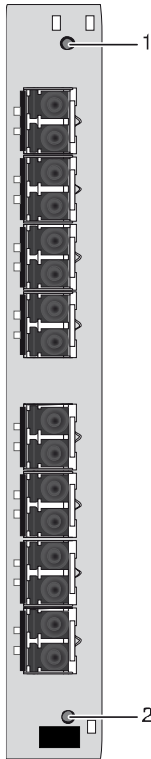

SFP Coax

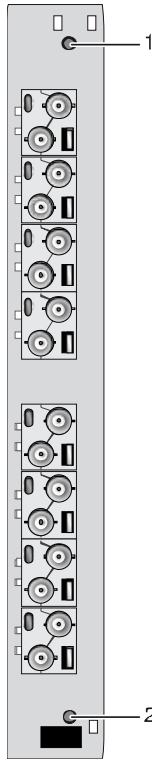

Matrix Grid



Front View

Status LEDs at I/O boards:

Pos.	LED	Status	Description
1	Status 1	Light blue	I/O board boot process
		Red flashing	I/O board registration process
		Red/ Yellow flashing	I/O board in Service Mode or firmware conflict with CPU board
		Green flashing	Operating condition, I/O board registered at the matrix
		Green	I/O board de-registered (locking pin pulled out)
2	Status 2	White	I/O board boot process
		Blue	I/O board registration process
		Blue flashing	Operating condition, communication active with CPU board active
		Red flashing	I/O board de-registered (locking pin pulled out)

Ports I/O Board

Cat X

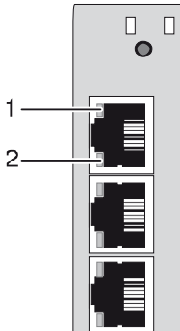

SFP Fiber

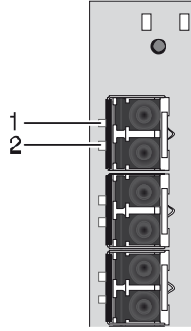

SFP Coax

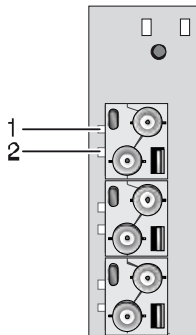

Matrix Grid

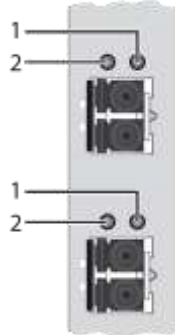

Front View

- 1 Status LED 1
- 2 Status LED 2

Status LEDs at the ports of the I/O boards:

Pos.	LED	Status	Description
1	Link status (orange)	Off	Port not activated
		Flashing	Port activated, no connection via interconnect cable
2	Link status (green)	Off	Port not activated
		Flashing	Port activated, no connection via interconnect cable

Pos.	LED	Status	Description
		On	Connection via interconnect cable ok, data traffic active

Fan Tray

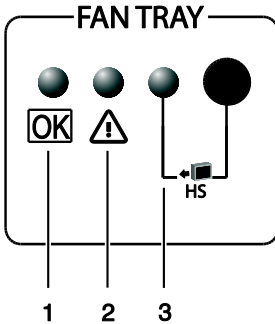

Front View

- 1 Status LED 1
- 2 Status LED 1
- 3 Hot Swap LED

Status LEDs of the fan trays:

Pos.	LED	Status	Description
1	Status 1 (green)	On	Operating condition
2	Status 2 (red)	Off	Operating condition
		On	Error indication
3	Hot Swap (blue)	Off	Hot Swap option deactivated
		On	Hot Swap option activated

Power Supply Unit Draco tera 576

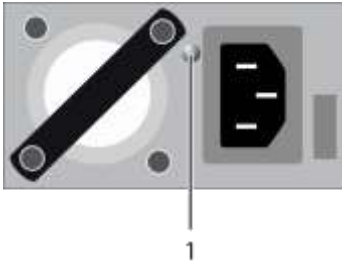

Front View

Status LEDs of the power supply units

Pos.	LED	Status	Description
1	Status LED	Green	Stand-by on; main output on
		Orange	Main output OCP or UVP or OVP
		Orange flashing	Fan Error; high temperature

Power Supply Unit Draco tera 288/160/152

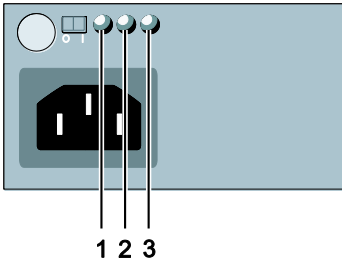

Front View

Status LEDs of the power supply units

Pos.	LED	Status	Description
1	AC Input OK (green)	On	Operating condition
2	DC Output OK (green)	On	Operating condition
3	O/T (yellow)	Off	Normal temperature
		On	High temperature

Power Supply Unit Draco tera 80/48

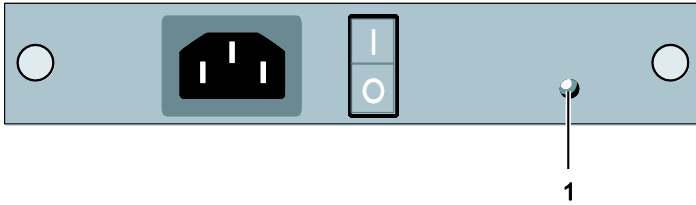

Front View

Pos.	LED	Status	Description
1	DC Input OK (green)	On	Operating condition
		Off	No power supply
	DC Input (red)	On	Power supply unit not active, Matrix is powered by second power supply unit
		Off	Operating condition

3.7.2 Port Status

The connections and the switching status between the various consoles and CPUs are shown in this menu.

You have the following option to access the menu:



Java Tool

The current port configuration of the Draco tera is illustrated in this menu.

➔ Select **View > Matrix** in the task area when connected to the matrix.

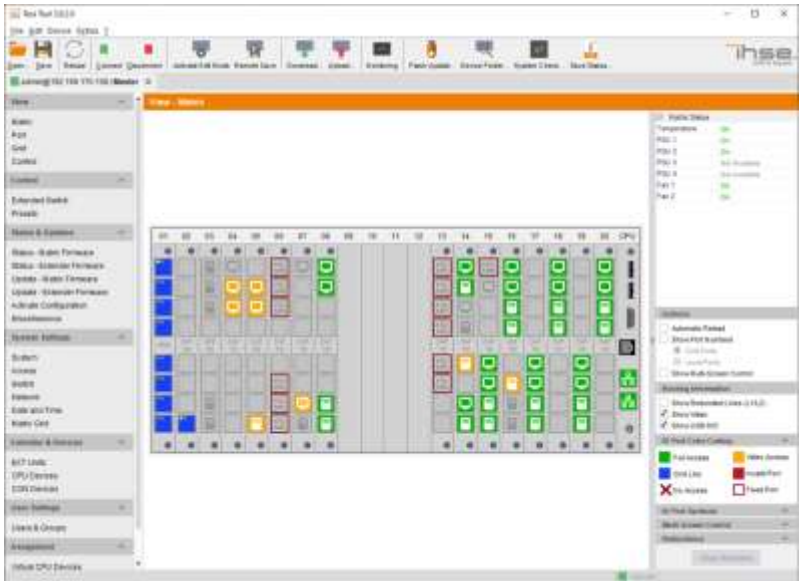

Menu **View - Matrix** (example #1)

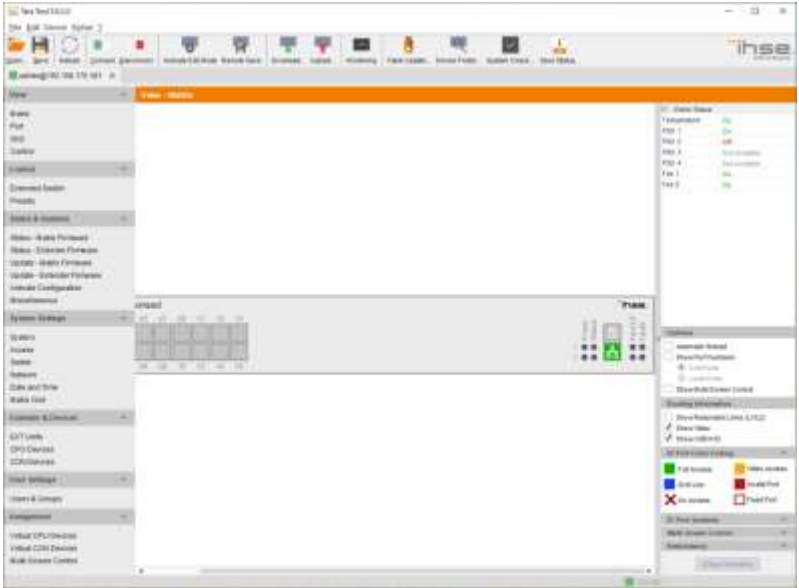













Menu **View - Matrix** (example #2)

The colors indicate the connection status:

Color	Description
Grey	Port not connected
Yellow	Video connection
Green	KVM connection
Red	Faulty Port
Blue	Port connected to another matrix via Grid Line

The symbol indicates the extender that is recognized and defined at a certain port:

Symbol	Description
	Port connected to a CPU Unit
	Port is connected to a CPU Unit that is switched to a CON Unit in Private Mode (see Chapter 3.7.4, Page 36).
	Port connected to a CON Unit
	Port connected to a CON Unit with Shared Access to a CPU.
	Port is connected to a CON Unit that is connected to a CPU Unit in Private Mode (see Chapter 3.7.4, Page 36).
	Port connected to a USB 2.0 CPU Unit
	Port connected to a USB 2.0 CON Unit
	Port is configured as Cascade-CON port for cascading of matrices.
	Port is configured as Cascade-CPU port for cascading of matrices.
	Port is a UNI port of an I/O board that can be used for USB 3.0 or SDI switching.
	UNI port is configured as CON port in order to connect USB 3.0 CON extenders, for example.
	UNI port is configured as CPU port in order to connect USB 3.0 CPU extenders, for example.



- Red framed ports are defined as "fixed" (e. g. for USB 2.0 connections).
- The port with four static blue squares is currently selected.
- If a port is selected, all other ports are transparent, except those connected to the currently selected port. A selection can be cleared by pressing the button **Clear Selection**.
- In Matrix View, a red cross on a port indicates that the console to be connected does not have access rights to the respecting CPU at this port.

- ➔ Press the left mouse button to show the extender information of the currently selected port on the right hand side of the working area.

The following information is available:

Field	Description
Extender Name	Name of selected extender
Extender Type	Type of selected extender
Port ID	Number of selected port
Device Name	Name of connected console or CPU
Connections	Listing of assigned connections to marked port (Full Access or Video Access)

- ➔ Press the right mouse button to open the context menu with additional functions for the currently selected port.

The following context functions are available:

Function	Description
Open Extender	The menu for definition of the currently selected extender will be opened
Open Device	The menu for definition of the currently selected console or CPU will be opened
Switch	The menu for execution of switching operations will be opened

In order to reload the **Matrix View** you have the following options:

- Press the key <F5> on a connected keyboard
- Execute **Edit > Reload** in the menu bar
- Press the Button **Reload** in the tool bar

3.7.3 Port Status Matrix Grid

In this menu the connections and the switching status between the various CON and CPU Devices are shown within the Matrix Grid.

The port view is divided into the different Grid matrices. As a result each matrix is displayed in an optimized view of 24 ports per line in order to be able to show also a larger number of ports.

You have the following option to access the menu:



Java Tool

The current port configuration of the Matrix Grid is illustrated in this menu.

➔ Select **View > Port** in the task area when connected to the matrix.

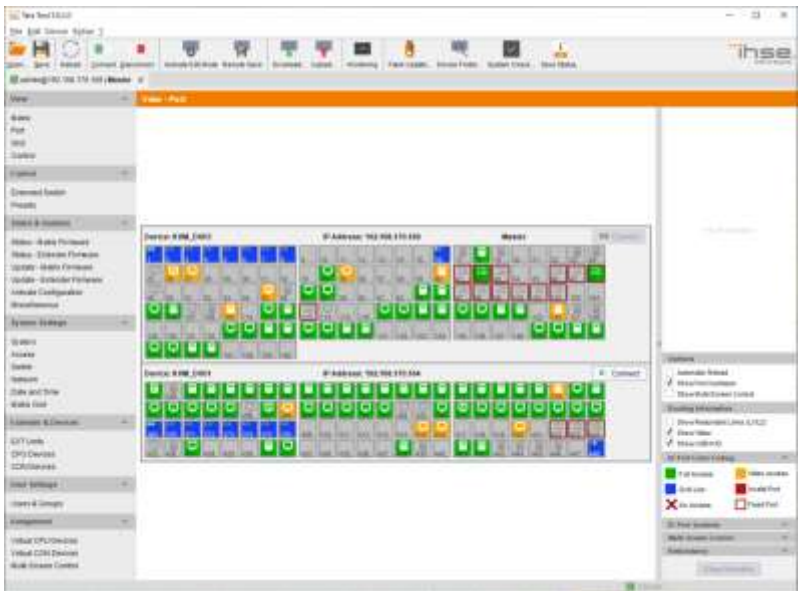

Menu View - Port



Functions, colors and symbols used in the Grid Port View are identical to those in the port status of the Matrix View see Chapter 3.7.2, Page 31.

3.7.4 Extender OSD

All extenders used with the Draco tera are provided with their own OSD to display the connection status of the console.

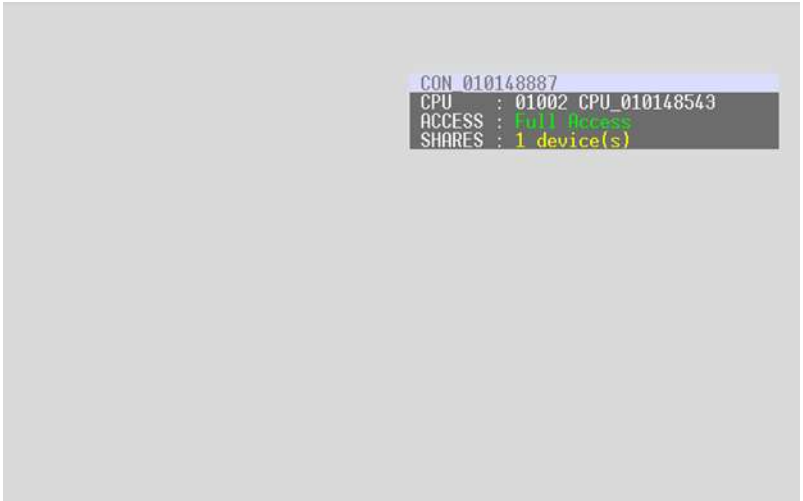

Example View Extender OSD

The following information is shown in the OSD menu:

Field	Description
CON	Name of console
CPU	<p>Name of currently connected CPU</p> <p>Color Coding:</p> <ul style="list-style-type: none"> Green: The connection to the selected CPU is completely established. Yellow: The connection to the selected CPU is partially established. Red: The connection to the selected CPU cannot be established. <p>Note: Possible reasons for any incomplete or non-established connection can be switched off extenders or insufficiently available Grid lines in Matrix Grid operation. In case of not having a grid line available to establish a connection, the additional message No more grid lines available will appear.</p>

Field	Description
ACCESS	<ul style="list-style-type: none"> • Full Access: Console has a KVM connection to the displayed CPU. • Video Access: Console has a video only connection to the displayed CPU. • Private Mode: Console has a Private Mode connection to the displayed CPU. • not connected: Console is not connected to a CPU.
SHARED	<p>x device(s) shows the exact number of devices that are connected to the current CPU of the console (e.g. 3 devices). If the field remains empty, no other devices are connected to the current CPU.</p>



If the options **Mouse Connect** or **Keyboard Connect** (see Chapter 5.4.4, Page 95) are used, the name of the console with keyboard / mouse control will be displayed on those consoles that do not have current K/M control. The console is displayed in yellow color under **Access**.

3.7.5 Network Status

The current network configuration is shown in this menu.

You have the following options to access the menu:



The following information is shown in this menu:

Field	Description
DHCP	Information whether the network settings are applied dynamically. Display Y (Yes) or N (No)
IP Address	Information about the IP address as provided manually or via DHCP
Subnet Mask	Information about the subnet mask as provided manually or via DHCP
Gateway	Information about the gateway address as provided manually or via DHCP
MAC ID	Information about the MAC address of the matrix

OSD

→ Select **Status > Network** in the main menu.

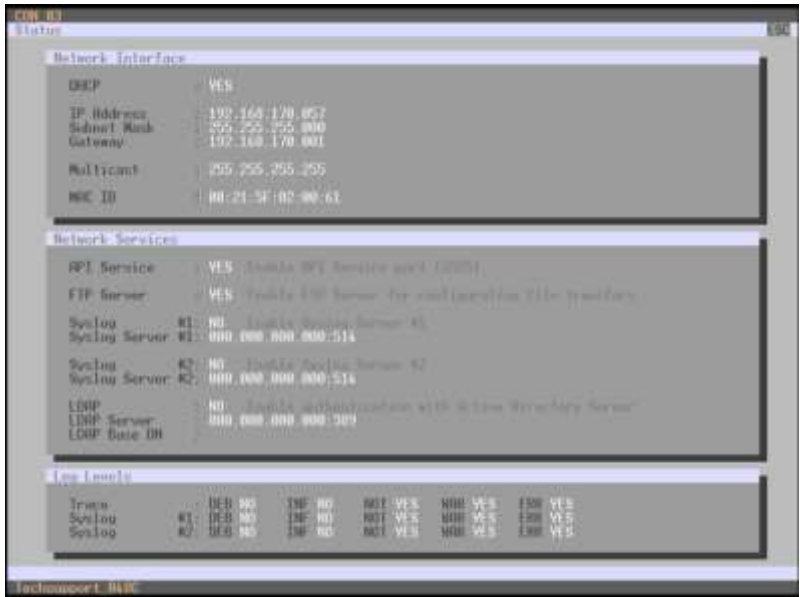

Menu **Status – Network**

Java Tool

1. Select **View > Matrix** in the task area.

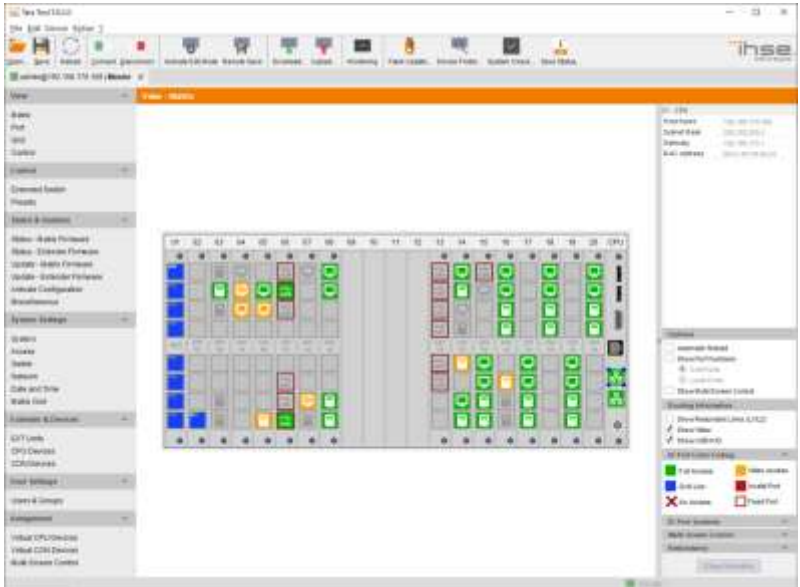

Menu **View - Matrix**

2. Use the left mouse button to click on the network port of the CPU board.

The corresponding network status will be shown on the right hand side of the working area.

The available information can be faded in or hidden by pressing the left mouse button on the "plus" or "minus" icon.

3.7.6 Firmware Status Matrix

The current firmware status of the installed boards is shown in this menu.

You have the following options to access the menu:



The following information is shown in this menu:

Field	Description
Name	Description of modules
Type	Type number
Ports	Number of ports
Version	Complete description of firmware version
Date	Date of firmware version
Status	Module status

OSD

➔ Select **Status > Firmware** in the main menu.

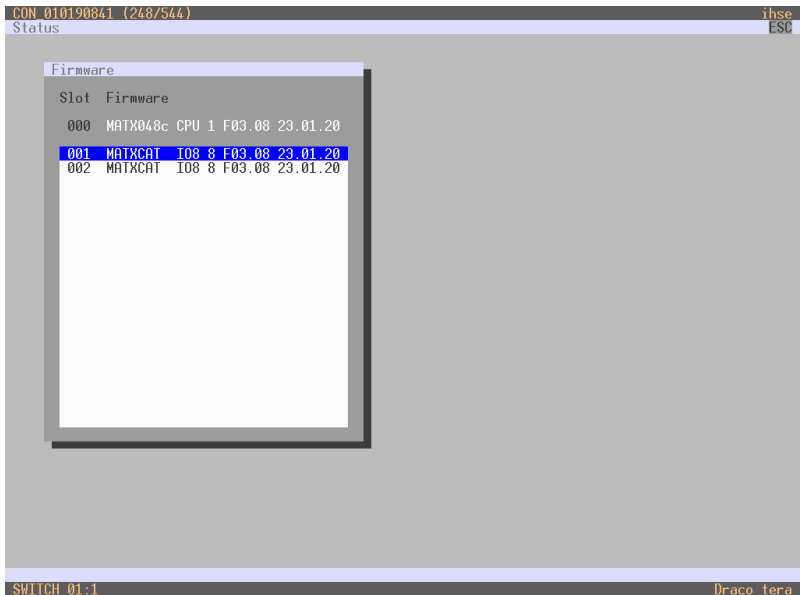

Menu **Status – Firmware**

Java Tool

1. Select **Status & Updates > Status - Matrix Firmware** in the task area.

ID	Name	Type	Path	Signal Number	Version	Date	Status
00	Firmware	FW	Ready
01	Firmware (Data Recovery)	FW	Ready
02	Firmware (External Firmware)	FW	Ready
03	Firmware (Internal Firmware)	FW	Ready
04	Firmware (User Firmware)	FW	Ready
05	Firmware (Data Recovery)	FW	Ready
06	Firmware (External Firmware)	FW	Ready
07	Firmware (Internal Firmware)	FW	Ready
08	Firmware (User Firmware)	FW	Ready
09	Firmware (Data Recovery)	FW	Ready
10	Firmware (External Firmware)	FW	Ready
11	Firmware (Internal Firmware)	FW	Ready
12	Firmware (User Firmware)	FW	Ready
13	Firmware (Data Recovery)	FW	Ready
14	Firmware (External Firmware)	FW	Ready
15	Firmware (Internal Firmware)	FW	Ready
16	Firmware (User Firmware)	FW	Ready
17	Firmware (Data Recovery)	FW	Ready
18	Firmware (External Firmware)	FW	Ready
19	Firmware (Internal Firmware)	FW	Ready
20	Firmware (User Firmware)	FW	Ready
21	Firmware	FW	Ready
22	Firmware (Data Recovery)	FW	Ready
23	Firmware (External Firmware)	FW	Ready
24	Firmware (Internal Firmware)	FW	Ready
25	Firmware (User Firmware)	FW	Ready
26	Firmware (Data Recovery)	FW	Ready
27	Firmware (External Firmware)	FW	Ready
28	Firmware (Internal Firmware)	FW	Ready
29	Firmware (User Firmware)	FW	Ready
30	Firmware (Data Recovery)	FW	Ready
31	Firmware (External Firmware)	FW	Ready
32	Firmware (Internal Firmware)	FW	Ready
33	Firmware (User Firmware)	FW	Ready
34	Firmware (Data Recovery)	FW	Ready
35	Firmware (External Firmware)	FW	Ready
36	Firmware (Internal Firmware)	FW	Ready
37	Firmware (User Firmware)	FW	Ready
38	Firmware (Data Recovery)	FW	Ready
39	Firmware (External Firmware)	FW	Ready
40	Firmware (Internal Firmware)	FW	Ready
41	Firmware (User Firmware)	FW	Ready
42	Firmware (Data Recovery)	FW	Ready
43	Firmware (External Firmware)	FW	Ready
44	Firmware (Internal Firmware)	FW	Ready
45	Firmware (User Firmware)	FW	Ready
46	Firmware (Data Recovery)	FW	Ready
47	Firmware (External Firmware)	FW	Ready
48	Firmware (Internal Firmware)	FW	Ready
49	Firmware (User Firmware)	FW	Ready
50	Firmware (Data Recovery)	FW	Ready
51	Firmware (External Firmware)	FW	Ready
52	Firmware (Internal Firmware)	FW	Ready
53	Firmware (User Firmware)	FW	Ready
54	Firmware (Data Recovery)	FW	Ready
55	Firmware (External Firmware)	FW	Ready
56	Firmware (Internal Firmware)	FW	Ready
57	Firmware (User Firmware)	FW	Ready
58	Firmware (Data Recovery)	FW	Ready
59	Firmware (External Firmware)	FW	Ready
60	Firmware (Internal Firmware)	FW	Ready
61	Firmware (User Firmware)	FW	Ready
62	Firmware (Data Recovery)	FW	Ready
63	Firmware (External Firmware)	FW	Ready
64	Firmware (Internal Firmware)	FW	Ready
65	Firmware (User Firmware)	FW	Ready
66	Firmware (Data Recovery)	FW	Ready
67	Firmware (External Firmware)	FW	Ready
68	Firmware (Internal Firmware)	FW	Ready
69	Firmware (User Firmware)	FW	Ready
70	Firmware (Data Recovery)	FW	Ready
71	Firmware (External Firmware)	FW	Ready
72	Firmware (Internal Firmware)	FW	Ready
73	Firmware (User Firmware)	FW	Ready
74	Firmware (Data Recovery)	FW	Ready
75	Firmware (External Firmware)	FW	Ready
76	Firmware (Internal Firmware)	FW	Ready
77	Firmware (User Firmware)	FW	Ready
78	Firmware (Data Recovery)	FW	Ready
79	Firmware (External Firmware)	FW	Ready
80	Firmware (Internal Firmware)	FW	Ready
81	Firmware (User Firmware)	FW	Ready
82	Firmware (Data Recovery)	FW	Ready
83	Firmware (External Firmware)	FW	Ready
84	Firmware (Internal Firmware)	FW	Ready
85	Firmware (User Firmware)	FW	Ready
86	Firmware (Data Recovery)	FW	Ready
87	Firmware (External Firmware)	FW	Ready
88	Firmware (Internal Firmware)	FW	Ready
89	Firmware (User Firmware)	FW	Ready
90	Firmware (Data Recovery)	FW	Ready
91	Firmware (External Firmware)	FW	Ready
92	Firmware (Internal Firmware)	FW	Ready
93	Firmware (User Firmware)	FW	Ready
94	Firmware (Data Recovery)	FW	Ready
95	Firmware (External Firmware)	FW	Ready
96	Firmware (Internal Firmware)	FW	Ready
97	Firmware (User Firmware)	FW	Ready
98	Firmware (Data Recovery)	FW	Ready
99	Firmware (External Firmware)	FW	Ready
100	Firmware (Internal Firmware)	FW	Ready

Menu **Status & Updates - Status - Matrix Firmware**

2. To read out the overall status of the matrix and store it locally (file extension **.zip**), select **Matrix > Save Status** or press the respective button in the symbol bar.

The various modules can be expanded and retracted in the **Name** column by clicking with the left mouse button on the plus or minus symbols.

By clicking on the plus resp. minus symbol in the upper right corner of the working area you can expand and retract all module information with one click of the left mouse button.

3.7.7 Firmware Status Extender

The current firmware status of connected extenders is shown in this menu. You have the following option to access the menu:



The following information is shown in this menu:

Field	Description
Name	Description of firmware
Type	Description of extender module
Ports	Number of ports
Cur. Version	Description of current firmware version
Cur. Date	Date of current firmware version

➔ Select **Status & Updates > Status - Extender Firmware** in the task area.

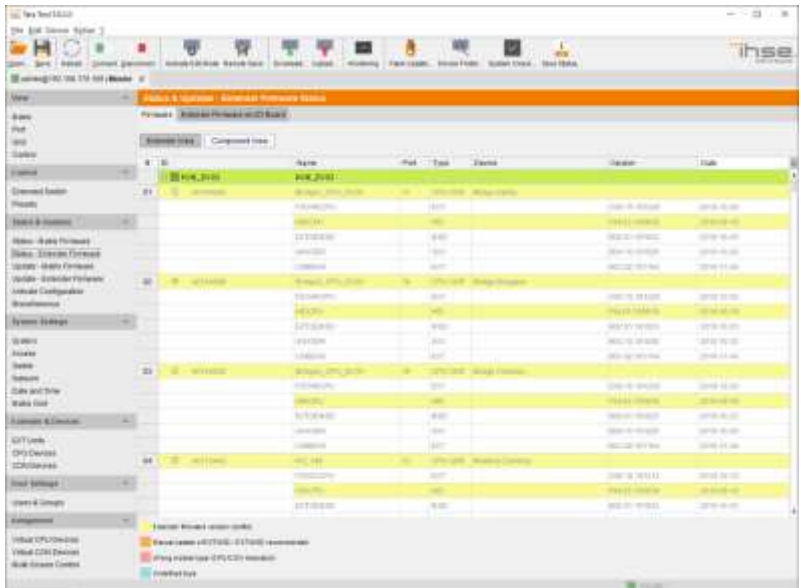

Menu **Status & Updates - Status - Extender Firmware**

3.8 Trace Function

All events, e.g. activities and switching operations of the Draco tera matrix, are logged and displayed in this menu.

This function is used for diagnostic purposes.

You have the option to request various trace views in the menu:



The following information is shown in this menu:

Field	Description
Date	Date stamp
Time	Time stamp
Message	Detailed description of the event

Trace possibilities

→ Select **Status > Trace** to check the matrix events.

3.9 Syslog Monitoring

The complete logging of the Draco tera matrix activities, switching operations and surveillance of the function of critical components like fans or power supply units takes place in this menu.

You have the following option to access the menu:



In order to start Syslog Monitoring proceed as follows:

- ➔ Select the symbol **Monitoring** in the symbol bar.

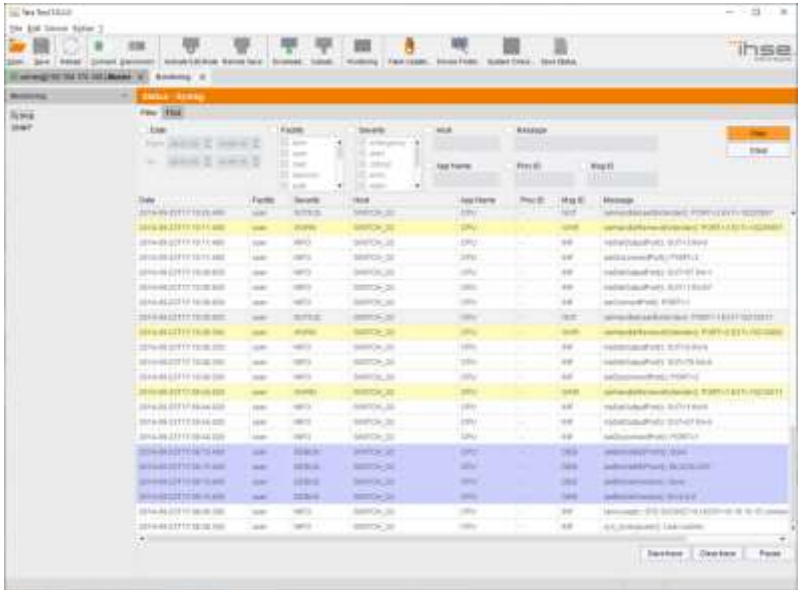

Menu **Monitoring** - Syslog

Logging of system activities starts when the **Monitoring** menu is opened and remains active until the tab is closed.



Syslog messages are transmitted via UDP. Therefore, port 514 within the used network should not be blocked, e.g. by a firewall.

During logging the activities are written continuously into logging files and stored locally. This process can be set with various options.

Options

→ Select **Extras > Options** in the menu bar and open the tab **Syslog**.

The following options are available:

Option	Description
Log File Directory	Default directory to store the log files
Log File Name	Default name of the log file
Log File Extension	Default extension for the log file
Daily Logfiles	Log files are stored every 24 hours (daily)
Maximum Log File Size (KB)	Allowed maximum size of log file
Maximum Number of Log Files	Allowed maximum number of log files
Autostart	When starting the Java Tool, the Syslog function will be started in the background
Open Monitoring Tab	When starting the Java Tool, the Monitoring tab will be opened



When reaching the maximum log file size, a new log file will be created. When reaching the maximum number of log files, the oldest one will be overwritten with the new information.

Filter Function

In order to filter relevant messages out of a number of logged activities of the Draco terra, the Syslog Monitoring offers various filter options.

In order to set and activate a filter, proceed as follows:

1. Set the desired filter option(s) by activating the respective checkbox(es).
2. Activate the filter settings by pressing the **Filter** button.
3. In order to deactivate an activated filter setting press the **Clear** button.

The following filter options are available:

Option	Description
Date	Messages for a defined date range will be filtered
Facility	Messages for a defined facility will be filtered
Severity	Messages for a defined severity will be filtered
Host	Messages for a defined host will be filtered
Message	Messages with defined text parts will be filtered



Filter options are not valid within the locally stored log files.

Recording Function

All messages shown in the Syslog are equipped with various recording functions.

- ➔ In order to store messages shown in the Syslog (filtered or unfiltered), press the **Save trace** button. The messages will be stored in a .txt file.
- ➔ In order to remove messages shown in the Syslog, press the **Clear trace** button.
- ➔ In order to stop recording messages, press the **Pause** button. In order to continue press the button again.

3.10 SNMP

The SNMP function allows all function-critical and safety-critical elements of the matrix to be monitored and queried. This function complies with the RFC 1157 conformance standard.



When using SNMP monitoring, it is recommended that a dedicated network is used to maintain continuous access. The read only community for the MIB file is **draco**.

You have the following options to configure the SNMP monitoring:



OSD

In order to activate the SNMP agent, proceed as follows:

1. Select **Configuration > SNMP** in the main menu.

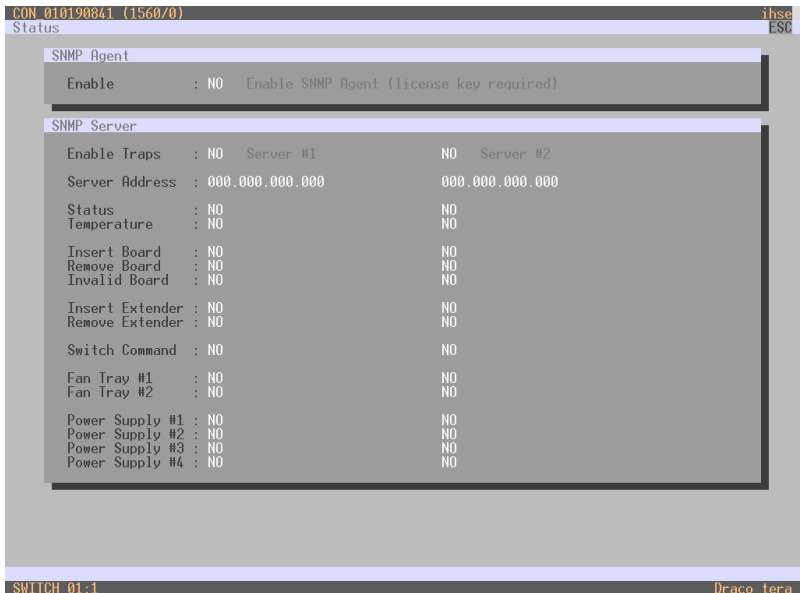
**Menu Configuration – SNMP**

2. Set the **Enable** option to **Y (Yes)** under **SNMP Agent**. By activating this option, the permission for an active query of the SNMP agent is granted.

In order to configure a SNMP server, proceed as follows:

1. Select **Configuration > SNMP** in the main menu.
2. Set the **Enable Traps** option to **Y (Yes)** within **SNMP Server**. This function allows an active transmission of trap messages from the SNMP agent to the SNMP server.
3. Set the IP address of the SNMP server within **Server Address**.
4. Activate the requested traps by enabling them to **Y (Yes)**.

You can select the following traps:

Trap	Description
Status	Notification about matrix status
Temperature	Notification about temperature within the matrix
Insert Board	Notification about insertion of a new I/O board into a slot
Remove Board	Notification about removal of an I/O board out of a slot
Invalid Board	Notification about a faulty I/O board
Insert Extender	Notification about a newly connected extender to the matrix, notification about a switched on extender, notification about a newly established link between extender and matrix
Remove Extender	Notification about a removed extender from the matrix, notification about a switched off extender, notification about an interrupted link between extender and matrix
Switch Command	Notification about a performed switching operation at the matrix
Fan Tray #1	Notification about the status of fan tray #1
Fan Tray #2	Notification about the status of fan tray #2
Power Supply #1	Notification about the status of power supply unit #1
Power Supply #2	Notification about the status of power supply unit #2
Power Supply #3	Notification about the status of power supply unit #3
Power Supply #4	Notification about the status of power supply unit #4

In order to query the SNMP status, proceed as follows:

➔ Select **Status > SNMP** in the main menu.



For an activation of the SNMP agent function or the SNMP server function, a restart of the matrix is necessary.

Two SNMP servers can be used at the same time.

Java Tool

In order to activate the SNMP agent, proceed as follows:

1. Select **System Settings > Network** in the task area.

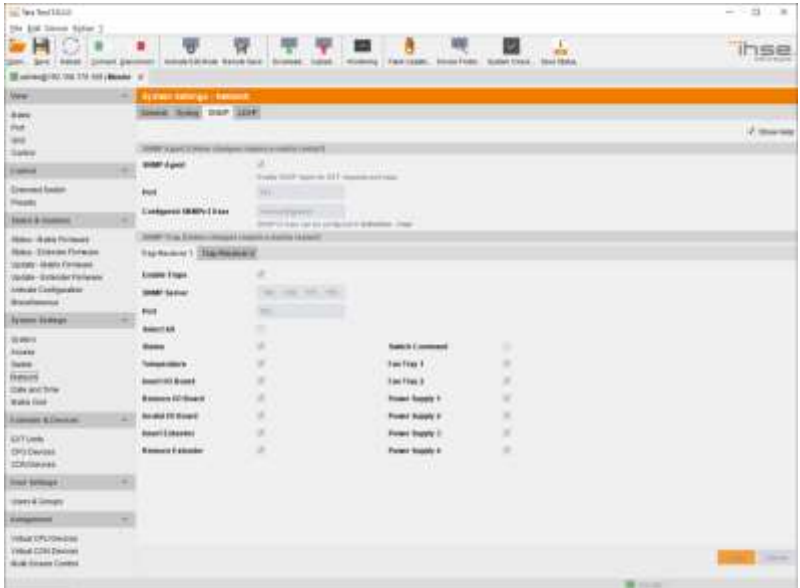

Menu **System Settings - Network**

2. Activate the **SNMP Agent** option in the **SNMP** tab. By activating this option, the permission for an active query of the SNMP agent is granted.

In order to configure a SNMP-Server, proceed as follows:

1. Select **System Settings > Network** in the task area.
2. Activate the **Enable Traps** option within **SNMP Server**. This function allows an active transmission of trap messages from the SNMP agent to the SNMP server.
3. Set the IP address of the SNMP within **SNMP Server**.
4. Activate the requested traps.



To activate the SNMP agent function or the SNMP server function, a restart of the matrix is required.

3.11 System Check

System Check offers a diagnostic function for checking the matrix configuration. The feature indicates suboptimal and faulty settings.

System Check is exclusively used for a confidence check and does not make any active changes in the configuration.

You have the following option to access the menu:



The following configuration parts are checked:

- Matrix Firmware
- Extender Firmware
- Multi-Screen Control
- Ext Units
- CPU Devices
- CON Devices
- User
- System Configuration
- Matrix Grid

The following notification levels can be shown:

Level	Description
OK (green)	System Check completed without any abnormalities
WARNING (yellow)	System Check revealed abnormalities in the configuration that point to incomplete parts of the configuration, firmware differences, duplications or unconnected extenders but without being system critical
ERROR (red)	System Check revealed errors in the configuration that can have both functional and system critical influences on the system.



If the messages "WARNING" and "ERROR" are generated by the System Check function, the respective problem will be described and a basic guideline will be provided.

In order to start System Check, proceed as follows:

➔ Select the **System Check** symbol in the symbol bar.

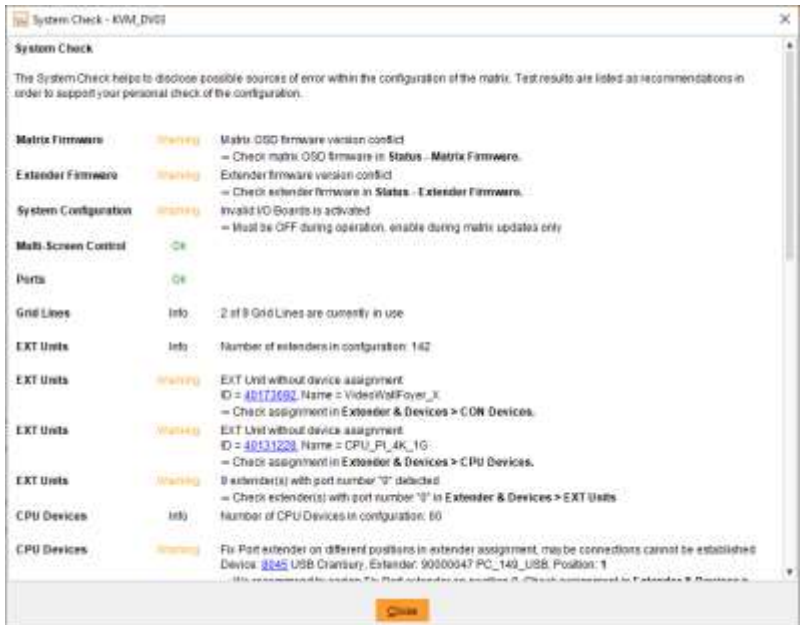

Menu – System Check

3.12 Device Finder

The Device Finder offers the possibility to find all matrices or SNMP boards that are located in the same subnetwork. This is useful, for example, if the IP address of a specific matrix is unknown and should be accessed via IP.

You have the following possibility to access the function:



The following device information is shown in the Device Finder:

Information	Description
Device	Name of device
Name	Name of the active configuration
IP address	Current IP address of the device
MAC Address	MAC address of the device
Type	Type of device



The last column of the Device Finders can be used to access the respective matrix directly using the button **Connect**.

In order to start the Device Finder, proceed as follows:

- ➔ Select the symbol **Device Finder** in the symbol bar.

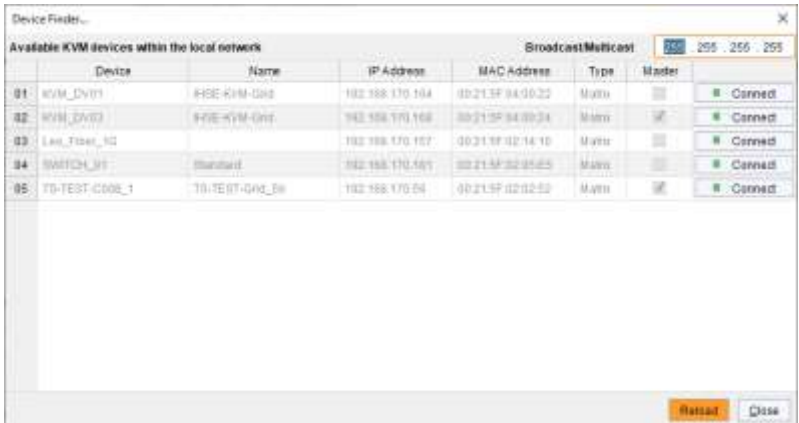

Menu – Device Finder

4 Installation

4.1 Package Contents

Your package contains the following items:

- Draco tera matrix
- 1x power cord per built-in power supply unit
- 1x serial control cable
- Mounting accessories
- Quick Setup



If anything is missing, contact your dealer.

4.2 System Setup



First time users are recommended to setup the system in the same room as a test setup. This will allow you to identify and solve any cabling problems, and experiment with your system more conveniently.

Setup of the matrix

1. Install the CPU and I/O boards.
2. Connect keyboard, mouse and monitor to the CPU board of the matrix.
3. Connect the matrix to the power supply.
4. Open OSD via keyboard command <'Hot Key'>, <o> and login with administrator rights in the main menu under **configuration** (see Chapter 5.2.1, Page 63).
5. Configure initially as requested.



After the configuration of the system it is recommended to save the configuration by selecting **Configuration > Save** and restart the matrix by selecting **Restart Matrix**.

6. Optional: Establish a network connection between the matrix and the Java Tool in order to set an extended configuration (see Chapter 5.2.2, Page 68).

The default IP address is 192.168.100.99 and DHCP is deactivated. When installing several matrices at the same time, it is strongly recommended to install them in sequence and to assign unique IP addresses in order to avoid IP address conflicts.

Setup of Extender

1. Connect the CON Units to the matrix by using the interconnect cables (Cat X or fiber).
2. Connect the CON Units to the input devices to be used (for example keyboard and mouse).
3. Connect the 5VDC power supply units to the CON Units.
4. Check the basic function of the CON Unit by opening the OSD via keyboard command <'Hot Key'>, <o>.
5. Connect the source (computer, CPU) to the CPU Unit of the extender by using the provided connection cables.
6. Connect the CPU Unit to the matrix using the interconnect cables (Cat X or fiber).
7. If you have a video matrix, connect the video source directly to the matrix using the interconnect cables (coax, fiber).
8. Connect the 5VDC power supply units to the CPU Units.
9. Start the system.

4.3 Example Applications

The Draco tera supports a wide and flexible range of system configurations:

A part of the Draco tera can be configured as a Single-Head work station, a part as Dual-Head, as Quad-Head or even as a video matrix for example. In addition there are configurations with KVM and USB 2.0 available.

In addition to OSD access by a keyboard connected to the CPU board or an extender CON Unit, other methods of control are available, including:

- Java Tool
- Serial interface

A connection to common media controls is also possible.

The following section shows typical exemplary installations of the Draco tera:

4.3.1 KVM Matrix

In Single-Head mode, up to 288 ports can be used either as an input or as an output port depending on components and equipment. Non-blocking access is available for all users, i.e. user access is not limited by the activities of another user.

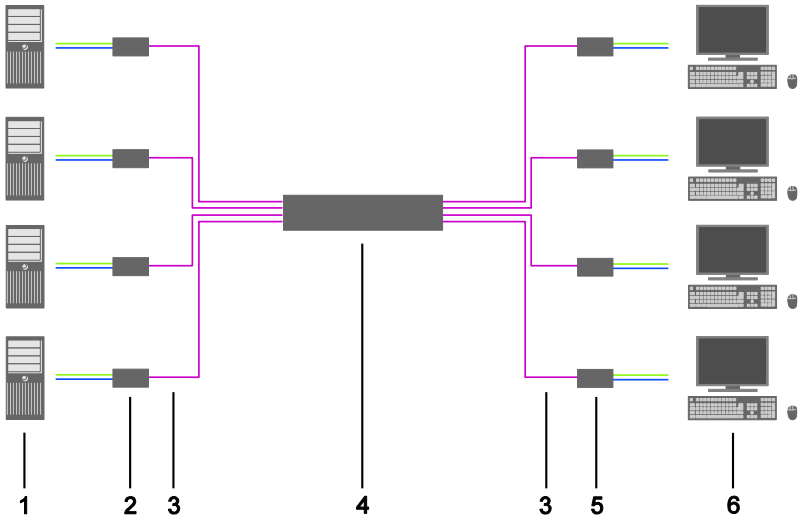

Single-Head KVM Matrix

- 1 Source (computer, CPU)
- 2 CPU Unit
- 3 Interconnect cable
- 4 Draco tera matrix
- 5 CON Unit
- 6 Console (monitor, keyboard, mouse)

If you have a Single-Head console, you can also get access to a Dual-Head or Quad-Head CPU for example. However control is only possible at monitor 1.

Any signal source can be switched to any number of monitors that will show the video signal at the same time. Audio may also be switched if required.

4.3.2 Video Matrix

If you use the Draco tera as a video matrix, up to 288 input ports can be switched to up to 288 output ports depending on components and equipment.

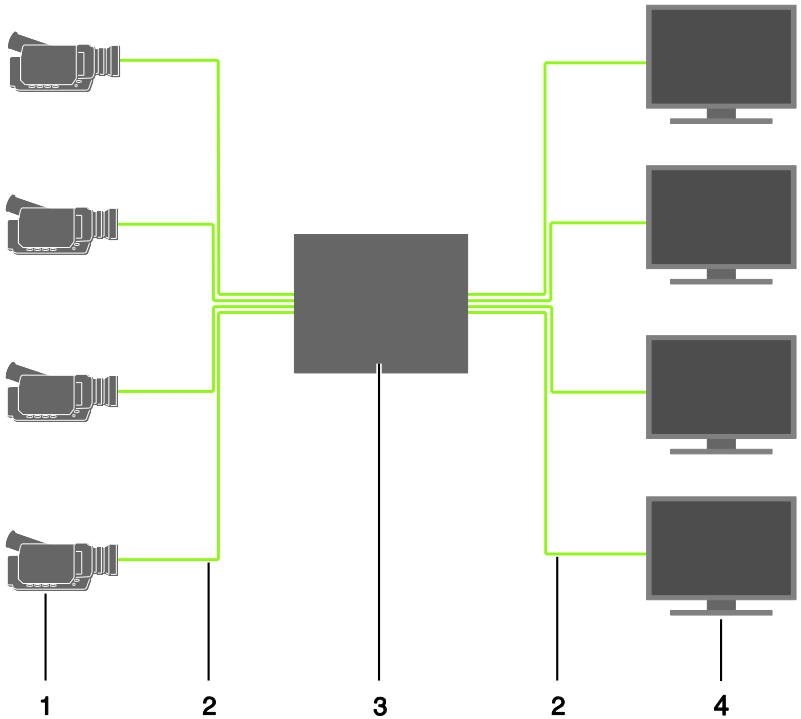

Video Matrix

- 1 Video source (e. g. SDI camera)
- 2 Interconnect cable
- 3 Draco tera matrix
- 4 Video sink (e. g. monitor)

4.3.3 Parallel Operation (Stacking)

If you have special configurations, especially at installations with several monitors per work station or additional support of USB 2.0 transmission paths, the number of connectable CPUs and consoles can be increased by a parallel operation (stacking) of several Draco tera devices.

One Draco tera matrix is defined as the **Master Matrix** and its IP address entered into the **Master IP Address** field (see Chapter 5.4.1, Page 83). All other matrices are defined as **Sub Matrices**. Sub matrices must be connected to the master matrix via network connector (RJ45) on the CPU board. The **Enable LAN Echo** option has to be activated at the master matrix (see Chapter 5.4.1, Page 83).

If a switching command is performed using the OSD, the synchronized matrices will also switch automatically.



Switching of stacked devices might be delayed by several seconds.

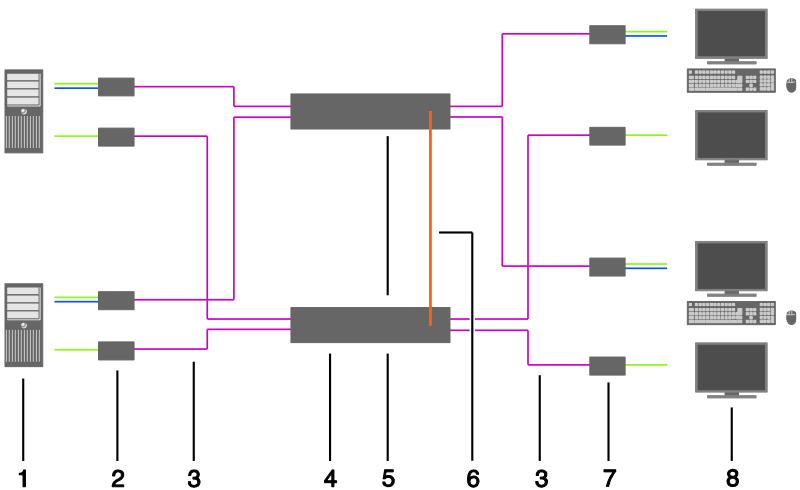

Parallel Operation (Stacking)

- 1 Dual-Head source (computer, CPU)
- 2 CPU Unit
- 3 Interconnect cable
- 4 Master matrix
- 5 Synchronized matrix
- 6 Network connection master matrix / synchronized matrix
- 7 CON Unit
- 8 Console (2x monitor, keyboard, mouse)

4.3.4 Matrix Grid

You can use a matrix grid for applications where the required number of ports is not sufficient or important connections need to be made to several matrices to provide redundancy.

A matrix grid consists of one master matrix and at least one sub matrix. In its maximum configuration, it can consist of up to 24 matrices.

In order to build a matrix grid, the grid matrices are interconnected by “Grid Lines”. In this case, the sub matrices can be connected directly to the master matrix or between themselves.

When arranging the grid lines, various grid setups can be realized, for example: a ring setup, a hub & spoke setup or a fully connected setup of matrices.

Grid lines can process signals bidirectional (**Smart Connect**). Per grid line, one KVM connection can be transmitted.

All switching operation will be exclusively performed through the Grid Master.

To configure the matrix grid, see Chapter 5.17, Page 185.

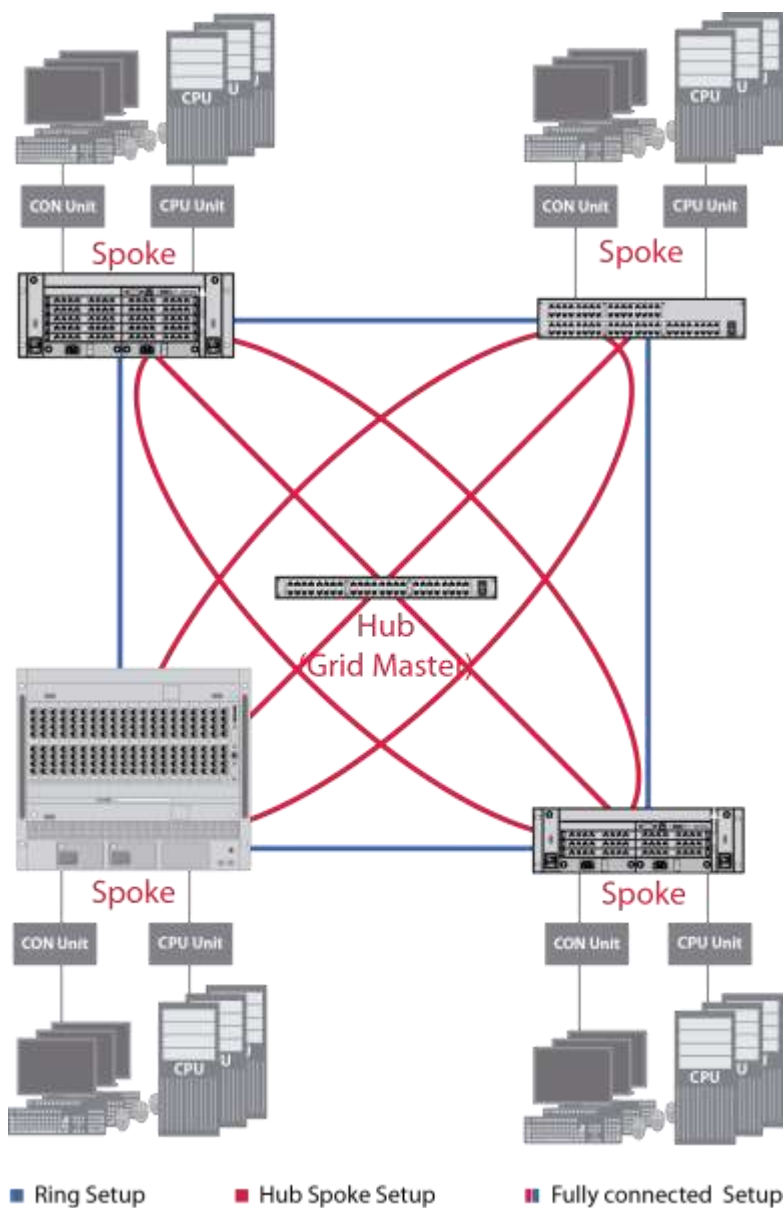

Matrix Grid

5 Configuration

5.1 Command Mode

The Draco tera includes a Command Mode that allows several functions to be controlled by keyboard commands during normal use.

To enter Command Mode use a 'Hot Key' sequence and to exit Command Mode, press <Esc>. While in Command Mode, the LEDs **Shift** and **Scroll** on the console keyboard will flash.



In Command Mode, normal keyboard and mouse operation will cease. Only selected keyboard commands are available.

If there is no keyboard command executed within 10 s after activating Command Mode, it will be deactivated automatically.

The following table lists the keyboard commands to enter and to exit Command Mode and to change the 'Hot Key' sequence:

Function	Keyboard Command
Enter Command Mode (default)	2x <Left Shift> (or 'Hot Key')
Exit Command Mode	<Esc>
Change 'Hot Key' sequence	<current 'Hot Key'>, <c>, <new 'Hot Key' code>, <Enter> Until 2011-30-09: <Left Ctrl> + <Left Shift> + <c>, <'Hot Key' Code>, <Enter>



<Key> + <Key>

Press keys simultaneously

<Key>, <Key>

Press keys successively

2x <Key>

Press key quickly, twice in a row (similar to a mouse double-click)

The 'Hot Key' sequence to enter Command Mode can be changed. The following table lists the 'Hot Key' Codes for the available key sequences:

'Hot Key' Code	'Hot Key'
0	Freely selectable (from 2012-01-12 on)
2	2x <Scroll>
3	2x <Left Shift>
4	2x <Left Ctrl>
5	2x <Left Alt>
6	2x <Right Shift>
7	2x <Right Ctrl>
8	2x <Right Alt>



In a combined KVM matrix / U-Switch configuration, choose different 'Hot Keys' for the KVM matrix and the U-Switch.

Set freely selectable 'Hot Key' (exemplary)

In order to set a freely selectable 'Hot Key' (e.g. 2x <Space>), use the following keyboard sequence:

<current 'Hot Key'>, <c>, <0>, <Space>, <Enter>

Set 'Hot Key' for direct OSD Access

Next to the 'Hot Key' for standard functions, this 'Hot Key' can be exclusively used for opening the OSD directly.

In order to select a 'Hot Key' from the 'Hot Key' table for a direct opening of the OSD, use the following keyboard sequence:

<current 'Hot Key'>, <f>, <'Hot Key' code>, <Enter>

In order to select a freely selectable 'Hot Key' (e.g. 2x <Space>) for opening OSD directly, use the following keyboard sequence:

<current 'Hot Key'>, <f>, <0>, <Space>, <Enter>

Reset 'Hot Key'

In order to set a 'Hot Key' back to default settings of the extender, press the key combination <Right Shift> + within 5 s after switching on the CON Unit or plugging in a keyboard.

In order to delete the 'Hot Key' for direct OSD access, use the following keyboard sequence:

<current 'Hot Key'>, <f>, <0>, , <Enter>

5.2 Control Options

The Draco tera contains an internal CPU that allows you to control all functions from any console without the need for an external CPU or media control.

You have the following options to access the Draco tera for configuration and operation:

- via OSD
- via Java Tool
- via serial interface

5.2.1 Control via OSD



Via OSD (On-Screen-Display) you set the configuration of the Draco tera operating system. The settings of the **Configuration** menu are described below. All other menus are described in later chapters.

You have the following options to enter the OSD of the Draco tera:

- via keyboard connected to the CPU board
- via keyboard connected to a CON Unit of an extender

Entering OSD

1. Start Command Mode with the 'Hot Key' (see Chapter 5.1, Page 61).
2. Press <o> to open OSD.
You will see a list of all available CPUs as a start menu.
3. Press <Esc> to enter the main menu.



If the **Enable CPU Selection** option is enabled in the **Configuration** menu, the selection list for switching CPU devices will be opened initially. This list can be skipped by pressing the <F7> key.

Leaving OSD

- ➔ Press <Esc> in the main menu or simultaneously <Left Shift> + <Esc> anywhere within the OSD.

The OSD will be closed without any further changes and the currently active CPU connection will be displayed.

Menu Structure

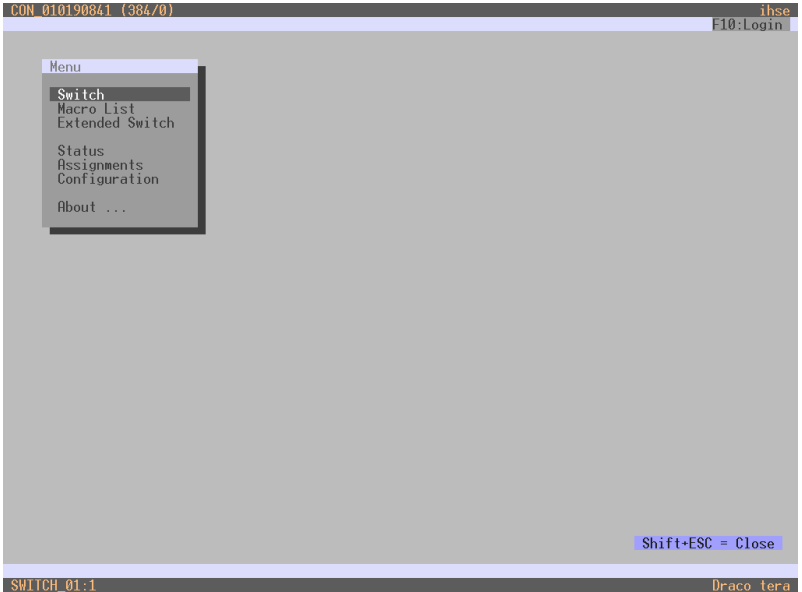

Example View

The general layout of the OSD is structured into three areas:

- Upper status area (topmost two text lines)
- Working area
- Lower status area (lowest two text lines)

Keyboard control

You can select the following keyboard commands:

Function	Keyboard Command
Left cursor - only within an input field or a switching screen	<Cursor Left>
Right Cursor - only within an input field or a switching screen	<Cursor Right>
<ul style="list-style-type: none"> In input fields: Line up (with wrap around) In menus: Line up (without wrap around) 	<Cursor Up>
<ul style="list-style-type: none"> In input fields: Line down (with wrap around) In menus: Line down (without wrap around) 	<Cursor Down>
Previous page in menus with more than one page	<Page Up>
Next page in menus with more than one page	<Page Down>
Next input field	<Tab>
Previous input field	<Left Shift> + <Tab>
Next option in selection fields	<+>
Previous option in selection fields	<->
In the CPU selection list with cursor on a CPU Group: Expand members of a group	<+>
In the CPU selection list with cursor on a CPU Group: Collapse members of a group	<->
Switching in selection fields between two conditions, e. g. between ON / OFF or Y (Yes) / N (No)	<Space>
<ul style="list-style-type: none"> In menus with input fields: Save data In menus: Select menu item 	<Enter>
<ul style="list-style-type: none"> In menus with input fields: Cancel data input without saving In menus with selection fields: Go back to the superior menu 	<Esc>

Sorting Function

Lists and tables in the Java Tool offer a sorting function for fast and smooth search.

The following sorting functions are available:

Function	Keyboard Command
Sort ID numbers in descending order by pressing the keyboard command once. Sort ID numbers in ascending order by pressing the keyboard command twice (ID).	<F1>
Sort ID names in descending order by pressing the keyboard command once. Sort ID names in ascending order by pressing the keyboard command twice (Name).	<F2>
Go to the next result in the list of results of the search field (Next).	<F3>
Go to the previous result in the list of results of the search field (Previous).	<F4>
Refresh the currently shown list (Refresh).	<F5>
Jump between the search field and the list of results (Find).	<F6>
Show unavailable CPUs	<F8>
Activate search function from the beginning of the name (Compare).	<F9>

Password request

You have to login with administrator rights to be able to set configurations.

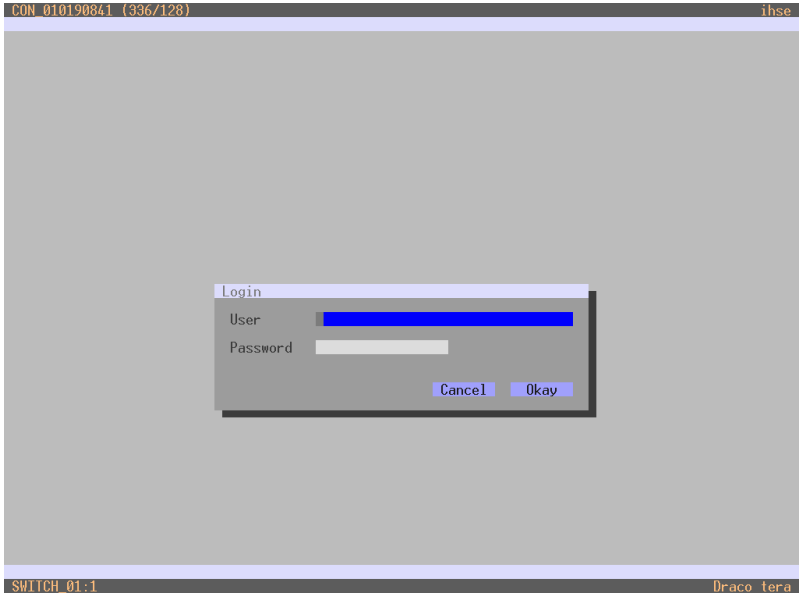

Menu **Login**

Access to the configuration menu requires administrator rights. User login is mandatory.

Field	Input
User	admin
Password	admin

By pressing <F10> in the main menu of the OSD, the login mask will be opened. In order to log out a user, press <F10> again.



For security reasons, please change the administrator password as soon as possible (see Chapter 5.4.1, Page 83).

5.2.2 Control via Java Tool



Requirements

If you want to use the Java Tool, the following requirements have to be fulfilled:

- Computer with an executable Java Tool and an installed Java Runtime Environment (JRE, version 1.7 or higher)
- Java Tool software
- Available network connection between the Java Tool and the matrix



Contact your system administrator concerning JRE and network connection.

Installation of the Java Tool

The Java Tool is available as a single executable program file that does not require a separate installation.

➔ Copy the tool after receiving the file to a directory on your computer.



If you do not have a copy of the Java Tool, contact your dealer.

Computer Connection to the Matrix



For a direct connection between computer and matrix, a cross-wired network cable is required.

For a connection between computer and matrix via switch or hub, a parallel assembled network cable is required.

Do not use a network connection between Java Tool and the matrix that is primarily used for transmitting audio data.

➔ Connect the network cable to the RJ45 ports of computer and CPU board of the matrix.

Start of the Java Tool

➔ Open the Java Tool by a double click on the program icon or use the <Enter> key of the keyboard.

Connection to the Matrix



At least FTP rights are required.

1. Open the Java Tool.
2. Select **Device > Connect** in the menu bar.
3. Enter the IP address in the popup input field according to the network configuration of the Draco tera (see Chapter 5.2.3, Page 77).
4. Enter the user name and password for the Draco tera (see Chapter 5.4.1, Page 83).
5. Confirm your inputs with the button **OK** or reject with **Cancel**.

The screenshot shows a 'Connect' dialog box with the following fields and values:

Field	Value
Hostname / IP Address	192.168.170.168
User	admin
Password	*****

Buttons: Login, Cancel

Menu **Connect**



Up to twelve connections between the matrix and the Java Tool can be established at the same time due to a limitation of available sockets.

Mouse Control

You can select the following mouse commands:

Function	Mouse Command
Menu selection, marking	Left mouse button
Open function specific selection menus	Double click left mouse button
Open context specific selection menus	Right mouse button

Keyboard Control

You can select the following keyboard commands:

Function	Keyboard Command
Cursor to the left	<Cursor Left>
Cursor to the right	<Cursor Right>
Line up	<Cursor Up>
Line down	<Cursor Down>
Previous page in input or status menus with more than one page	<Page Up>
Next page in input or status menus with more than one page	<Page Down>
Next field in input menus	<Tab>
Previous field in input menus	<Left Shift> + <Tab>
<ul style="list-style-type: none"> Switching in selection fields between two conditions (checkmark or not). Open already marked fields with editing or selecting possibility. 	<Space>
<ul style="list-style-type: none"> In menus: Data saving Menu item selection 	<Enter>
<ul style="list-style-type: none"> Leave tables Jump from tables into the next field 	<Ctrl> + <Tab>
<ul style="list-style-type: none"> Leave tables Jump from tables into the previous field 	<Ctrl> + <Left Shift> + <Tab>



Various functions within the menus in the menu bar can be executed with the provided keyboard commands (e. g. press <Ctrl> + <S> to execute **Save**) that are listed to the right of the respective menu item.

Reload Options

The information shown in the Java Tool can be reloaded in different ways.

- Via <F5> on the used keyboard
- Via **Edit > Reload** in the menu bar
- Via "Reload"-Symbol in the symbol bar

Context Function

The Java Tool offers several context functions that support user-friendly and effective operation. The context functions are described in the respective chapters.

- ➔ To execute a context function, use the right mouse button on the corresponding field and select the desired function.

Sorting Function

Lists and tables in the Java Tool offer a sorting function for fast and smooth search.

1. Ascending: Click left mouse button once on the header of the column to be sorted.
The sort status is indicated by an arrow that points upwards.
2. Descending: Click left mouse button once on the header of the column to be sorted.
The sort is displayed by an arrow that points downwards.
3. Cancel sort: Click left mouse button once or twice on the head of the sorted column.
The arrow displayed disappears.

Filter Function

Lists and tables in the Java Tool offer a filter function that allows a fast and smooth search.

1. To activate a filter, use the right mouse button to click on the header of the column to be filtered and select **Set Filter**.
2. Write the word or part of a word that has to be filtered into the header.
The filter results are shown immediately.
3. In order to delete a filter, use the right mouse button to click on the header of the column that has to be filtered and select **Clear Filter**.



An active filter is indicated by an asterisk in the header.
The filter function is based on the functional principle of common web search engines.

Offline Configuration

Configuration and system settings via Java Tool can be changed in offline mode without a direct connection between matrix and Java Tool.

In order to activate a matrix configuration, proceed as follows:

1. Select **File > Upload** in the menu bar.
2. Enter the IP address of the matrix (see Chapter 5.4.5, Page 99) and the name and password of the user authorization and select the storage location of the new configuration (**default** or **config01-08**) in the **Select Configuration Slot** menu.
3. Select **Device > Connect** in the menu bar and enter the IP address of the matrix and the name and password for user authorization.
4. Select **Status & Updates > Activate Configuration** in the task area and select the storage location that has been selected in step 2.
5. Use the **Activate** button to open the selected configuration within the matrix.

The connection and the open tab will be closed and the matrix will be restarted.



During the activation of a configuration, the matrix is temporarily unavailable.

Options menu

The Java Tool can be adapted and customised by editing various default settings.

In order to activate or change the default settings, proceed as follows:

- ➔ Select **Extras > Options** in the menu bar. The tab **Default Settings** will open.

The following default settings parameters can be changed:

Option	Description
IP / Hostname	Default IP address of the matrix required for connection
User	Default user name required for connection
Configuration Directory	Default directory for configuration files
Firmware Directory	Default directory for update files
Status Directory	Default directory for the firmware status
Import / Export Directory	Default directory for import and export files
Presets Directory	Default directory for macro files

In order to set various font sizes for the Java Tool, proceed as follows:

1. Select **Extras > Options** in the menu bar.
2. Open the **Miscellaneous** tab.
3. Select the desired font size (**normal** or **large**).

Report

The Java Tool is equipped with a report function that shows the current switching status and all relevant parts of the matrix configuration in a PDF file.

In order to create a report, proceed as follows:

1. Select **File > Report...** in the menu bar. A selection assistant will be opened.
2. Select contents that should be included in the report (**Matrix View**, **EXT Units**, **CPU Devices**, **CON Devices** and **Users**) and confirm with the button **Next >**.
3. Select the preferred location for storage of the report and confirm with the **Finish** button.

The report will be created as a PDF file.

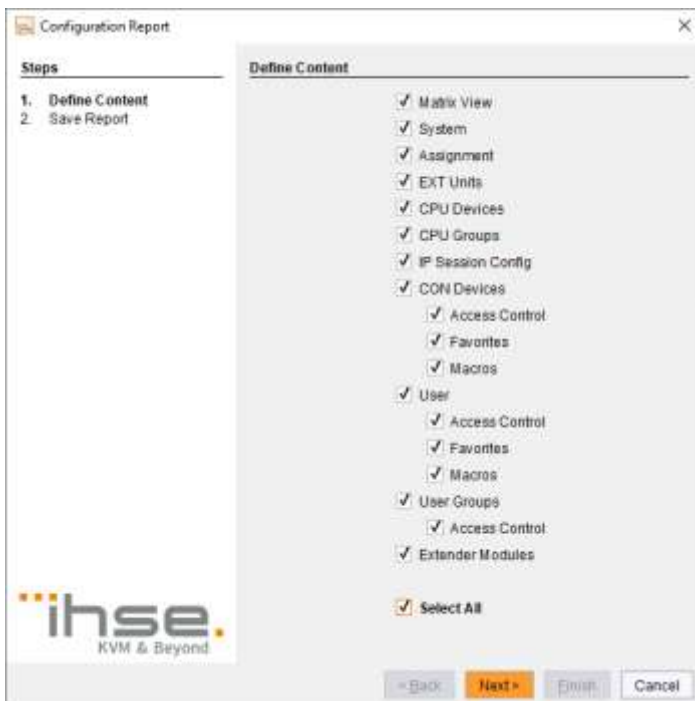

Menu **File > Report**



The report function can be used in both online or offline mode of the Java Tool.

5.2.3 Control via Serial Interface



The Draco tera operating system offers various functions for an operation via serial interface. There are telegrams for Switching single or all connections available, both unidirectional and bidirectional. In addition, there are telegrams for an overall definition of the total switching status and for saving and loading such switching states.

The Draco tera optionally provides an echo of all affected switching operations via serial interface or network interface. This aids continuous tracking of a matrix configuration and enables your own applications to be updated.

As an additional application you can parallelly switch matrix clones as synchronized matrices (**Stacking**) via serial network interface.

5.3 Assignment

The Draco tera offers the option of a console specific or a CPU specific assignment.

- Assign virtual CPUs to real CPUs.
- Assign real consoles to virtual consoles.

5.3.1 Virtual CPU

You can assign virtual to real CPUs in this menu.

With this function the effort of switching several consoles to the same CPU can be reduced. If several consoles are connected to a virtual CPU that is assigned to a real CPU, you only have to change the real CPU once and all consoles will receive the video signal of the new CPU.

It is possible to assign either one or several real CPUs to a virtual CPU.

You have the following options to access the menu:



OSD

➔ Select **Assignments > Virtual CPU Devices** in the main menu.

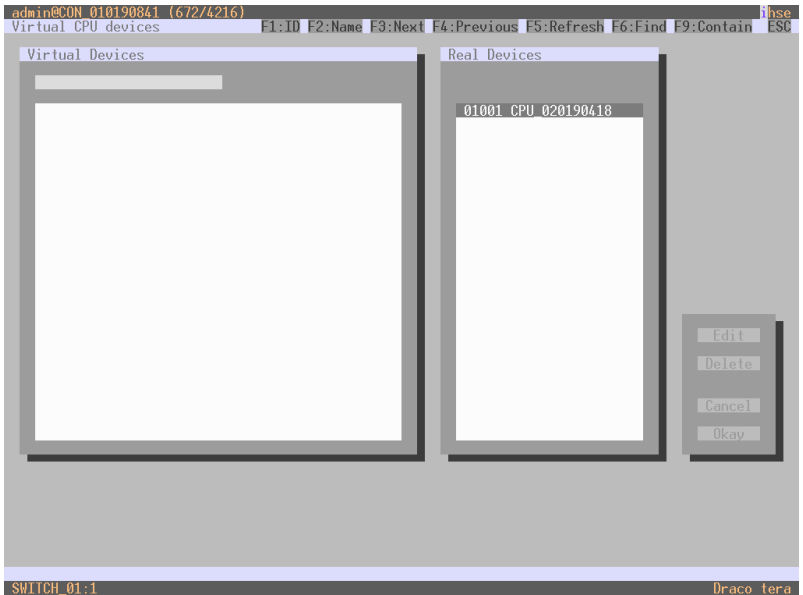

Menu **Assignments – Virtual CPU Devices**

For an assignment, proceed as follows:

1. Select the virtual CPU in the **Virtual Devices** list that has to be assigned to a real CPU.
2. Press the **Edit** button.
3. Select the CPU in the **Real Devices** list that has to be assigned to the selected virtual CPU.
4. Press the **Okay** button to confirm the assignment.
The assignment will be made.



Only one virtual CPU can be assigned to a real CPU.

Java Tool

➔ Select **Assignment > Virtual CPU Devices** in the task area.

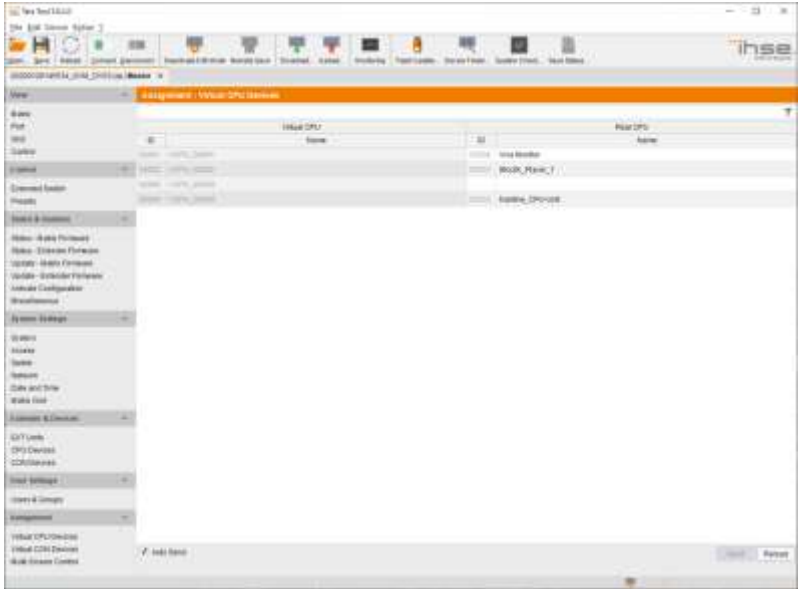

Menu **Assignment – Virtual CPU Devices**

For an assignment, proceed as follows:

1. Select a virtual CPU in the **Virtual CPU** list.
2. Double click in the **Real CPU** column to display a list of all available real CPUs.
3. Select a real CPU.

You can select the following buttons:

Button	Function
Send	Send assignments to the matrix
Reload	Reload changes



When the **Auto Send** function in the left lower corner of the work area is ticked, switching operations will be completed immediately without user confirmation by means of the **Send** button.

The selection boxes in the **Real CPU** column contain a filter function for an easy selection of a single CPU from a larger pool of CPUs (see Chapter 5.2.2, Page 68).

The Java Tool offers the option to switch directly from the **Assignment** menu to the **Definition** menu to check specific settings for the respective console or CPU.

- ➔ Use the right mouse button to select the respective console or CPU and select **Open CON Device** or **Open CPU Device**.

5.3.2 Virtual Console

You can assign real consoles to virtual consoles in this menu.

This function reflects changes in permission made to virtual consoles onto real consoles.

Virtual consoles can be switched in the same way as real consoles. Real consoles that are assigned to a virtual console that is connected to a CPU will receive the video signal. The last-assigned console will also have control of the keyboard and mouse.

You have the following options to access the menu:



OSD

→ Select **Assignments > Virtual CON Devices** in the main menu.

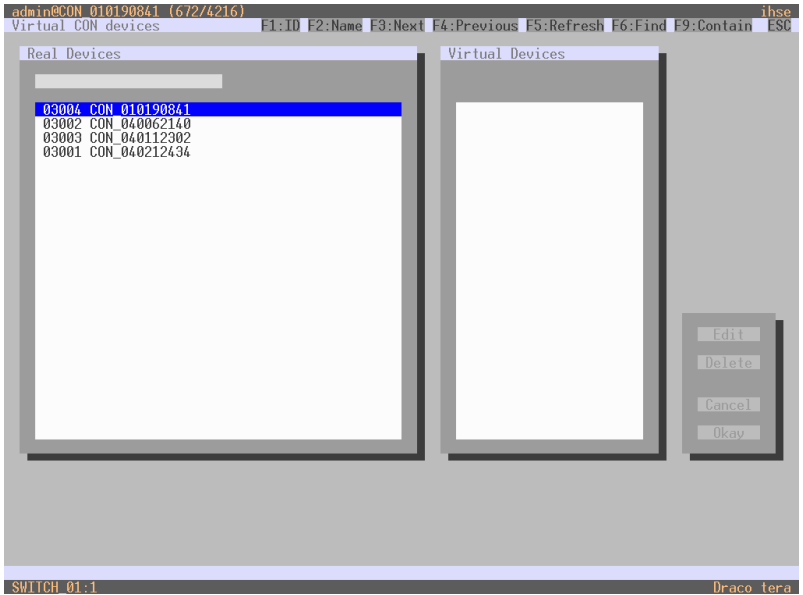

Menu **Assignments – Virtual CON Devices**

For an assignment, proceed as follows:

1. Select the real console in the **Real Devices** list that has to be assigned to a virtual CPU.
2. Press the **Edit** button.
3. Select the virtual console in the **Virtual Devices** list that has to be assigned to the selected real console.
4. Press the **Okay** button to confirm the assignment.
The assignment will be made.



A virtual console can be assigned to more than one real consoles.

Java Tool

➔ Select **Assignment > Virtual CON Devices** in the task area.

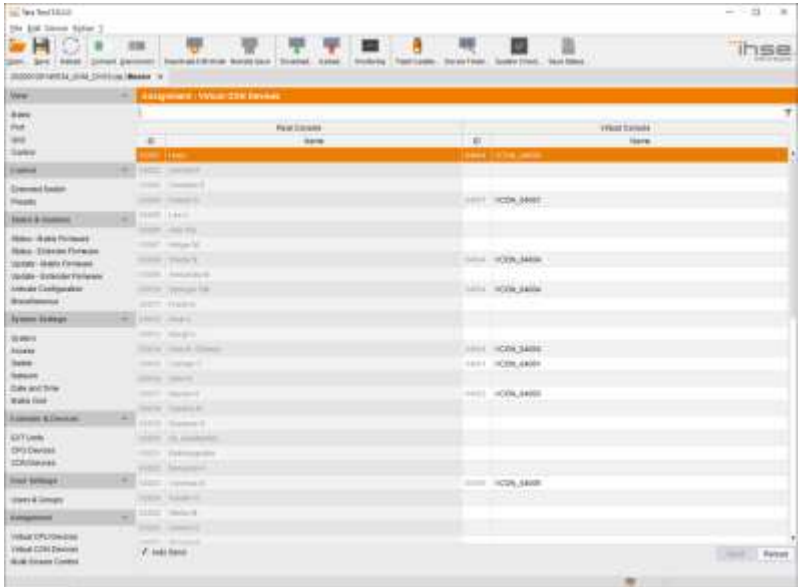

Menu **Assignment – Virtual CON Devices**

In order to place an assignment, proceed as follows:

1. Select the required real console in the **Real Console** table.
2. Double click in the **Virtual Console** column to display a list of all available virtual consoles.
3. Select the required virtual console.

You can select the following buttons:

Button	Function
Send	Send assignments to the matrix
Cancel	Reject changes



When the **Auto Send** function in the left lower corner of the work area is ticked, switching operations will be completed immediately without user confirmation by means of the **Send** button.

The selection boxes in the **Virtual Console** column contain a filter function for an easy selection of a single CON from a larger pool of CON (see Chapter 5.2.2, Page 68).

5.4 System Settings

You have the option to configure the following system settings at the Draco tera.



The configuration of the system settings can only be done by users with administrator rights.

5.4.1 System Data

The system configuration is set in this menu.

You have the following options to access the menu:



You can select the following settings:

Field	Selection	Description
Device	Text	Enter the device name of the matrix (default: SWITCH_01)
Name	Text	Enter the name of the configuration that is used to save the current settings (default: Standard)
Info	Text	Additional text field to describe the configuration (default: Factory settings)
Sub Matrix	activated	If the matrix is defined as a sub matrix in the OSD, the user will lose control. Control can be recovered by using the keyboard command <Shift>, <Shift>, <s>, <o>. The OSD for the matrix that has been defined as sub matrix will be reopened.
	deactivated	Function not active (default)
Load Default	activated	Starting the matrix after a restart or a switch-on with the default configuration.
	deactivated	Starting the matrix after a restart or a switch-on with the last saved configuration (default).

Field	Selection	Description
Auto Save	activated	Save the current configuration of the matrix in the flash memory periodically. Note: During the save operation, the matrix will not be operational. Saving takes place every 600 seconds, as long as changes of the configuration or switching operations have been executed in the meantime.
	deactivated	Function not active (default)
Enable COM Echo	activated	Send all switching commands performed in the matrix as an echo via serial interface. Note: This function should be enabled when using a media control via serial interface.
	deactivated	Function not active (default)
Enable LAN Echo	activated	Send all switching commands performed in the matrix as an echo via LAN connection. Note: This function should be enabled when using a media control via LAN connection or when using stacking with two ore more matrices.
	deactivated	Function not active (default)
Enable Redundancy	activated	Automatically switch to the second link of a connected redundant CON Unit when losing the primary link of a CPU Unit (default) Note: This function will have to be activated for both matrices in a fully redundant setup
	deactivated	Function not active
Synchronize	activated	Synchronize the sub matrix to the switch status of the master matrix.
	deactivated	Function not active (default)
Echo Only	activated	Synchronize the matrix according to the echo of a second matrix. Note: This is a bidirectional synchronization where both matrices have to be configured as Synchronize with the Master IP of the respective other matrix.
	deactivated	Function not active (default)
Master IP Address	Numerical value	Set the network address of the master matrix (default value: 000.000.000.000)

Field	Selection	Description
Invalid IO-Boards	activated	Keep I/O boards with incorrect or invalid firmware online in the matrix. Note: In order to keep an I/O board with wrong or damaged firmware online in the matrix, the maintenance mode of the matrix will be activated. During maintenance mode, you can only work.
	deactivated	Shut down I/O boards with incorrect or invalid firmware automatically (default).
Remove IO-Boards	activated	Shut down of I/O boards in Draco tera 576 if the 2nd CPU board is not available. Connection will be disconnected.
	deactivated	Function not active (default)
Online Config.	activated	Activate Online Configuration option for Java Tool.
	deactivated	Function not active (default)
Hor. Mouse Speed 1/x	1-9	Adjustment of the horizontal mouse speed, 1 = slow, 9 = fast (default value: 4)
Ver. Mouse Speed 1/x	1-9	Adjustment of the vertical mouse speed, 1 = slow, 9 = fast (default value: 5)
Double Click Time	100-800	Adjustment of the time slot for a double click (default value: 200 ms)
Keyboard layout	Region	Set the OSD keyboard layout according to the keyboard used (default: German (DE))

OSD

➔ Select **Configuration > System** in the main menu.

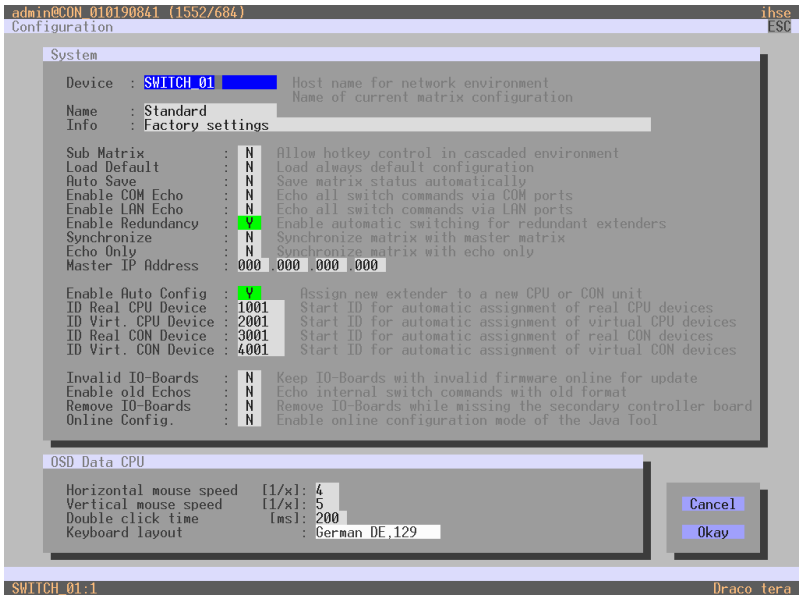

Menu Configuration – System

You can select the following buttons:

Button	Function
Cancel	Reject changes
Save	Save changes

Java Tool

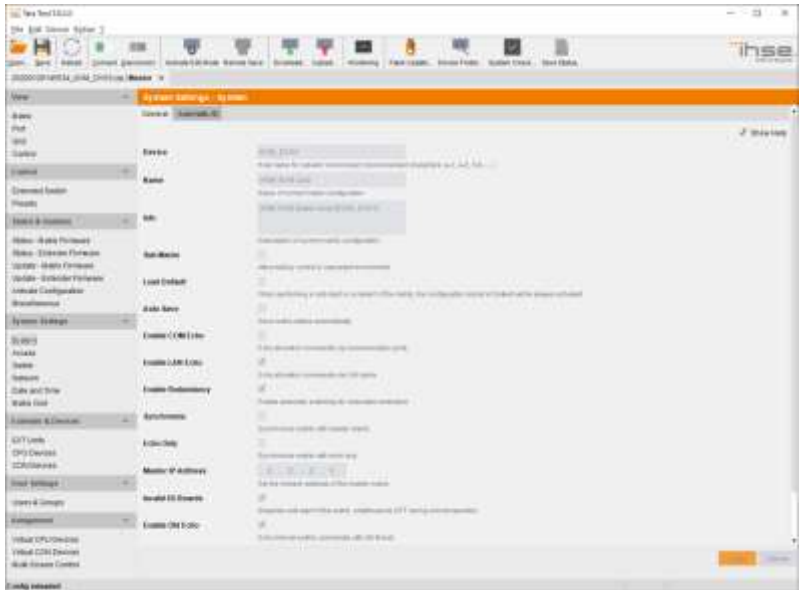

Menu System Settings - System

5.4.2 Automatic ID

Settings for automatic creation of CPU and CON Devices when a new extender unit is connected are made in this menu.

You have the following options to access the menu:



You can select the following settings:

Field	Selection	Description
Enable Auto Config	activated	Automatic creation of a new CPU or CON Device if new extender units are connected (default)
	deactivated	Function not active
ID Real CPU Device	Numerical value	Initial value of the automatic ID for real CPUs (default value: 1000)
ID Virtual CPU Device	Numerical value	Initial value of the automatic ID for virtual CPUs (default value: 2000)
ID Real CON Device	Numerical value	Initial value of the automatic ID for real CONs (default value: 3000)
ID Virtual CON Device	Numerical value	Initial value of the automatic ID for virtual CONs (default value: 4000)

OSD

➔ Select **Configuration > System** in the main menu.

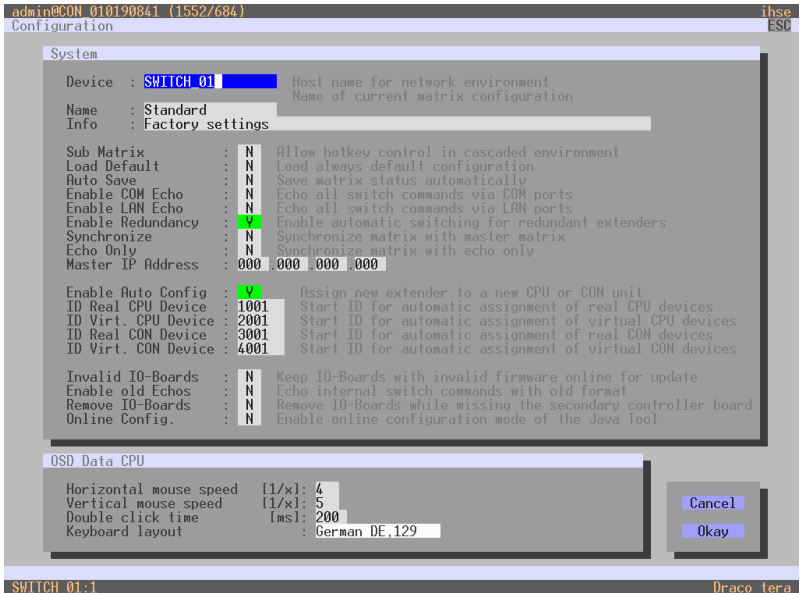

Menu Configuration – System

You can select the following buttons:

Button	Function
Cancel	Reject changes
Save	Save changes

Java Tool

➔ Select the tab **Automatic ID** in **System Settings > System**.

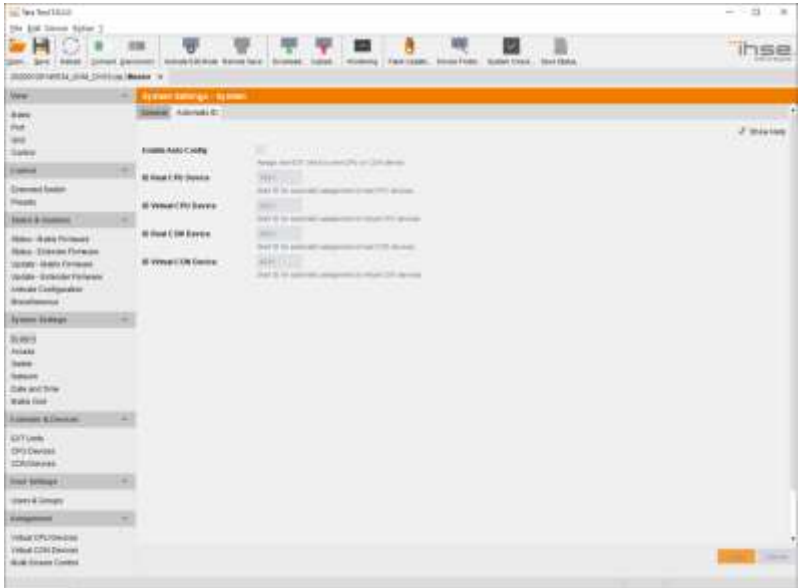

Menu **System** – **Automatic ID**

5.4.3 Access

The access configuration is set in this menu.

You have the following options to access the menu:



You can select the following settings:

Field	Selection	Description
Force User Login	activated	The user has to login with a user name and a password once to enter OSD. Thereafter the user remains logged in until he explicitly logs out or an auto logout is effected. Note: When using the Force User Login function, console favorites and console macros still remain active.
	deactivated	Function not active (default)
Enable User ACL	activated	CPU access is restricted according to the permissions in the ACL (Access Control List). <ul style="list-style-type: none"> User login is required. Switching by keyboard 'Hot Keys' requires a prior login.
	deactivated	Function not active (default)
Enable Console ACL	activated	CPU access is restricted according to the permissions in the respective Console ACL (Access Control List). No login required
	deactivated	Function not active (default)
OR User/CON ACL	activated	The user obtains the sum of access rights from the console and his personal access rights after logging in (extended access)
	deactivated	Function not active (default)
AND User/CON ACL	activated	The user obtains the common divisor of access rights from the console and his personal access rights after logging in (reduced access)
	deactivated	Function not active (default)

Field	Selection	Description
Enable new User	activated	Newly created users automatically receive access to all CPUs
	deactivated	Function not active (default)
Enable new CON	activated	Newly created CON Devices automatically receive access to all CPUs
	deactivated	Function not active (default)
Auto Disconnect	activated	Upon opening the OSD, the console will be automatically disconnected from the current CPU.
	deactivated	Function not active (default)
OSD Timeout	0-999 seconds	Period of inactivity after which OSD will be closed automatically. <ul style="list-style-type: none"> Select 0 seconds for no timeout (default: 0 seconds)
Auto Logout	0-999 minutes	Period of inactivity of a logged-in user at a console after which he will be automatically logged out. There may be a disconnect because of the logout, depending on the defined rights in each CON and user ACL. <ul style="list-style-type: none"> Select 0 minutes for an automatic user logout when leaving OSD. <ul style="list-style-type: none"> Using the setting -1 allows the user to be logged in permanently, until a manual logout is executed. The timer is not active as long as the OSD is open. (default: 0 minutes)
Keep CPU	activated	Keep the connection to the CPU Device active in the background after Auto Logout. After a new login there is no need to re-connect to the CPU Device.
	deactivated	Function not active (default)
Show CPU	activated	Permanently show the name of the currently connected CPU Device in the Connection Info box.
	deactivated	Function not active (default)

OSD

→ Select **Configuration > Access** in the main menu.

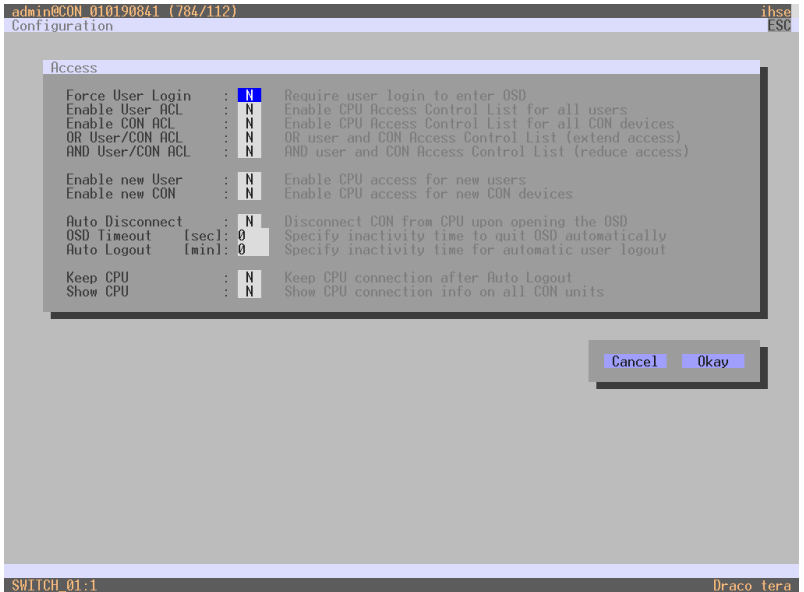

Menu **Configuration** – Access

You can select the following buttons:

Button	Function
Cancel	Reject changes
Save	Save changes

Java Tool

➔ Select **System Settings > Access** in the task area.

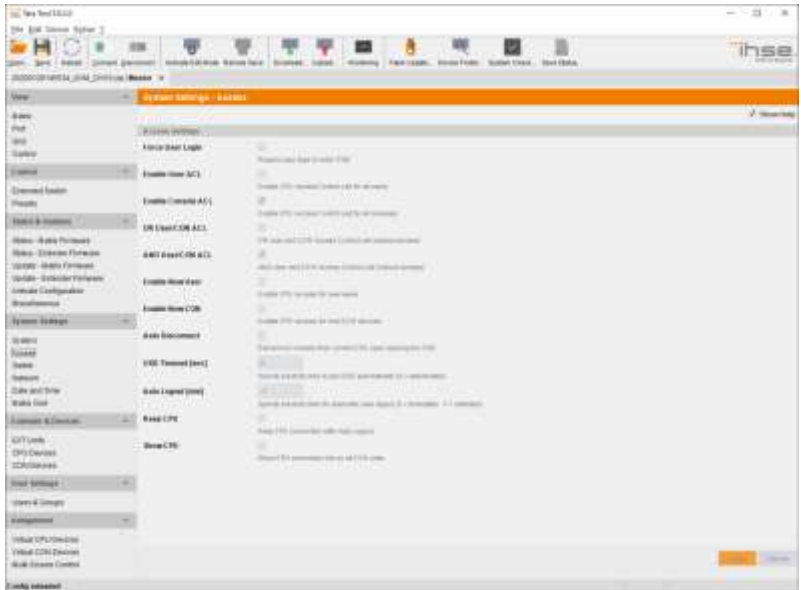

Menu **System Settings - Access**

5.4.4 Switch

The configuration of the switching parameters is set in this menu.

You have the following options to access the menu:



You can select the following settings:

Field	Selection	Description
Video Sharing	activated	The user can switch to any CPU as an observer, including ones that are already assigned to another user (observer without keyboard/mouse access). <ul style="list-style-type: none"> • Note: Switching with the key <Space>, not <Enter>. • The operator will not be informed if further users connect as an observer to the CPU that is connected to his console.
	deactivated	Function not active (default)
Force Connect	activated	The user can connect to every single CPU as an operator, including ones that are related to another user. <ul style="list-style-type: none"> • Note: The previous user is set to video only status. • To share K/M control, Force Connect has to be activated.
	deactivated	Function not active (default)
Force Disconnect	activated	Extension of Force Connect : If the user connects as an operator to a CPU already related to another user, the previous user will be disconnected. Note: To share K/M control Force Disconnect has to be deactivated.
	deactivated	Function not active (default)

Field	Selection	Description
CPU Auto Connect	activated	If a console is not connected to a CPU, you can establish an automatic connection to the next available CPU by hitting any key or mouse button.
	deactivated	Function not active (default)
CPU Timeout	0 – 999 minutes	Period of inactivity after which a console will be automatically disconnected from its current CPU (default value: 0 minutes)
Keyboard Connect	activated	Activate request of K/M control by keyboard event (key will be lost)
	deactivated	Function not active (default)
Mouse Connect	activated	Activate request of K/M control by mouse event
	deactivated	Function not active (default)
Release Time	0-999 seconds	<p>Period of inactivity of a connected console after which K/M control can be requested by other consoles connected to the CPU.</p> <ul style="list-style-type: none"> • Note: Set "0" for an immediate transfer in real-time. • Only one console can have keyboard and mouse control at the same time. The other consoles that are connected to the same CPU have a video only status (default value: 10 seconds)
Macro Single Step	activated	Execute macro commands sequentially
	deactivated	Function not active (default)



If the **Keyboard Connect** and/or **Mouse Connect** options are activated, the **Release Time** condition will have to be met until a new user will gain control.

OSD

→ Select **Configuration > Switch** in the main menu.

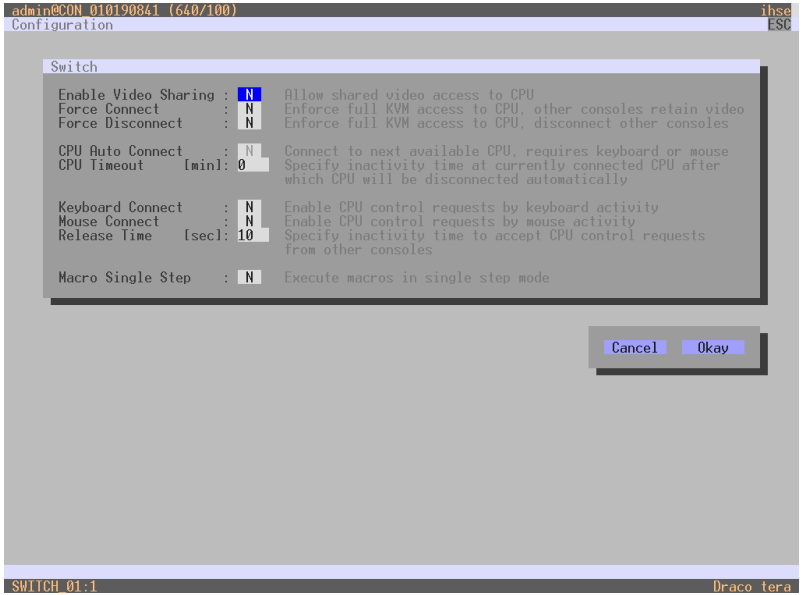

Menu **Configuration - Switch**

You can select the following buttons:

Button	Function
Cancel	Reject changes
Save	Save changes

Java Tool

➔ Select **System Settings > Switch** in the task area.

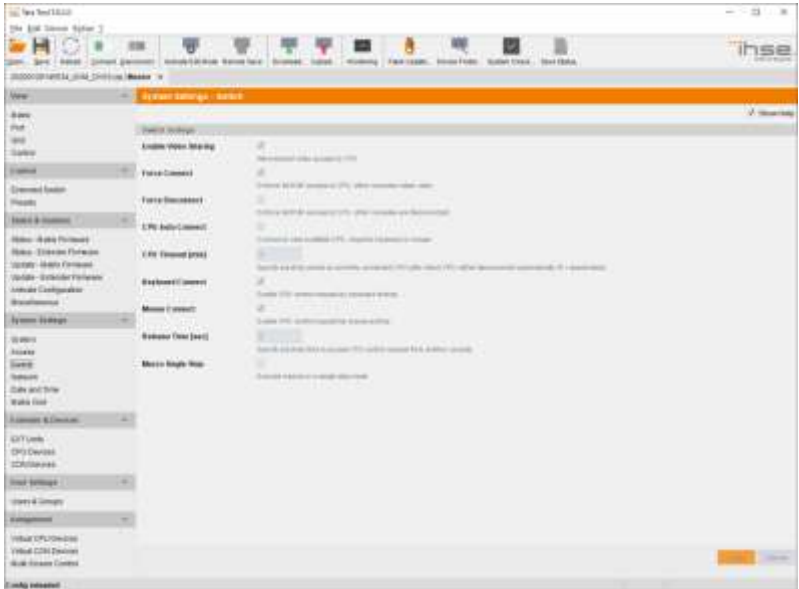

Menu System Settings - Switch

5.4.5 Network

The network configuration is set in this menu.

You have the following options to access the menu:



You can select the following settings:

Field	Selection	Description
DHCP	activated	The network settings are automatically supplied by a DNS server Note: If DHCP is activated and there is no physical network connection available, the boot times might increase. 2nd field for redundant CPU board
	deactivated	Function not active (default)
IP address	Byte	Input of the IP address, if DHCP is not active (default: 192.168.100.99) Note: 2nd field for redundant CPU board
Subnet Mask	Byte	Input of the subnet mask in the form "255.255.255.0", if DHCP is not active (default: 255.255.255.0) Note: 2nd field for redundant CPU board
Multicast	Byte	Input of the Multicast address, if there is a Matrix Grid in use within a Multicast group (default: 255.255.255.255)
Gateway	Byte	Input of the subnet mask in the form "192.168.1.1", if DHCP is not active Note: 2nd field for redundant CPU board. When using the controller board 480-CTRL2, entering a gateway is obligatory.
API Service	activated	LAN interface at the Draco tera activated for access via Java Tool (API service port 5555)
	deactivated	Function not active
SSL	activated	Activate SSL encryption for API, Java Tool API, Java Tool und Matrix Grid communication (only with 480-CTRL2).
	deactivated	Function not active (default)

Field	Selection	Description
Syslog #1/#2	activated	Syslog server for status request is active
	deactivated	Function not active (default)
Syslog Server #1/#2	Byte	Input of the IP address of the Syslog servers in the form "192.168.1.1" and of the Syslog port (default: 514)
LDAP	activated	LDAP for the request of information from a user administration is active
	deactivated	Function not active (default)
LDAP TLS/SSL	activated	Enable a secured transmission (transport layer security) for the Active Directory access.
	deactivated	Function not active (default)
LDAP Server	Byte	Input of the IP address for the LDAP-Servers in the form "192.168.1.1" and the LDAP port (Default: 389)
LDAP Base DN	Text	Input of the LDAP Base DN according to the existing stucture of the user directory
Trace	DEB	Activate debug messages in Trace (default: NO) Note: The debug messages are exclusively for matrix diagnostics. They only should be activated after consultation with the manufacturer. Otherwise an increased traffic of data might limit the performance of the CPU board.
	INF	Activate information messages in Trace (default: NO)
	NOT	Activate notification messages in Trace (default: YES)
	WAR	Activate warning messages in Trace (default: YES)
	ERR	Activate error messages in Trace (default: YES)

Field	Selection	Description
Syslog #1/#2	DEB	Activate debug messages in Syslog (default: NO) Note: The debug messages are exclusively for matrix diagnostics. They only should be activated after consultation with the manufacturer. Otherwise an increased traffic of data might limit the performance of the CPU board.
	INF	Activate information messages in Syslog (default: NO)
	NOT	Activate notification messages in Syslog (default: YES)
	WAR	Activate warning messages in Syslog (default: YES)
	ERR	Activate error messages in Syslog (default: YES)



Activate the modified network parameters by restarting the matrix.



Consult your system administrator before modifying the network parameters. Otherwise unexpected results and failures can occur in combination with the network.

OSD

➔ Select **Configuration > Network** in the main menu.



Menu Configuration – Network

You can select the following buttons:

Button	Function
Cancel	Reject changes
Save	Save changes

Release of Network Ports

The following ports are used by the matrix depending on the configuration and have to be released at the security gateway, if necessary. The ports only will have to be released, if you want to use the respective function.

Function	Port
FTP	21 / TCP
DNS	53
SNTP	123 / UDP
SNMP	161/162 / both UDP
LDAP	389
Syslog	514 / UDP
API	5555 / TCP (5565 for SSL)
Broadcast	5556 / UDP (5566 for SSL)
Matrix-Grid	5557 / TCP (5576 for SSL)

Java Tool

➔ Select **System Settings > Network** in the task area.

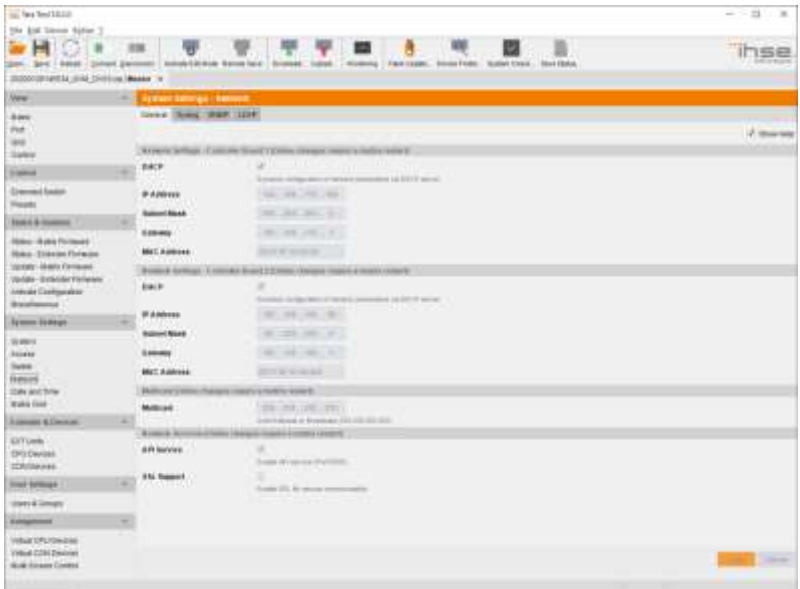

Menu System Settings - Network

5.4.6 Date and Time

Date and Time are set in this menu, based on Simple Network Time Protocol (SNTP).

You have the following options to access the menu:



You can select the following settings:

Field	Selection	Description
SNTP Client	activated	Enable network time server synchronization
	deactivated	Function not active (default)
SNTP Server	Byte	Input of the SNTP server IP address (default: 000.000.000.000)
Time Zone	Region	Set your specific time zone
Month	1–12	Enter month
Date	1–31	Enter date
Year	1–99	Enter year
Day	1–7	Enter day of the week
Hours	0–23	Enter hour
Minutes	0–59	Enter minute
Seconds	0–59	Enter second



Date format according to the English notation.

OSD

→ Select **Configuration > Date+Time** in the main menu.

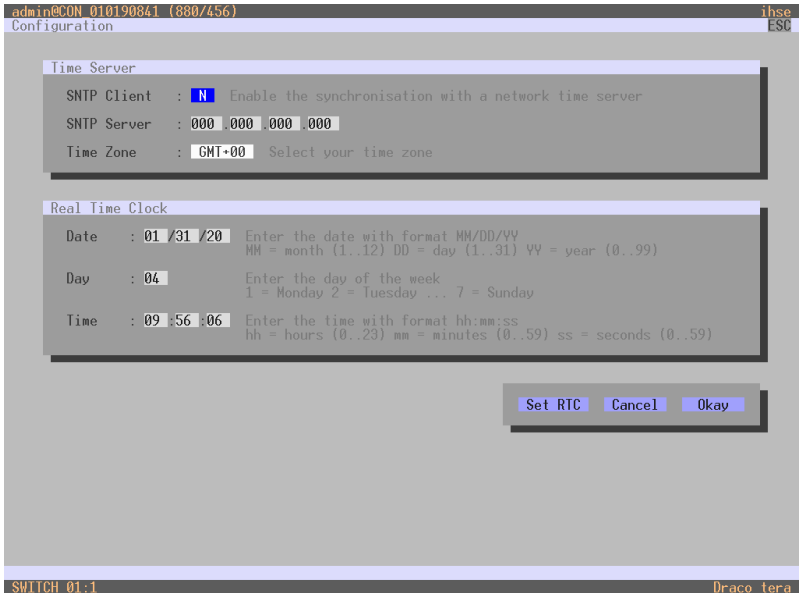

Menu Configuration – Date + Time

In order to configure a time server, proceed as follows:

1. Set the **SNTP Client** option to **Y** (Yes).
2. Enter the IP address of your SNTP server in the **SNTP Server** field.
3. Select your time zone in the **Time Zone** field.
4. Press the **Okay** button to confirm your settings.
5. Restart the matrix. The system time will be now provided by the SNTP server.

In order to set the real time clock without using SNTP, proceed as follows:

1. Set the current date in the **Date** field.
2. Set the current Day in the **Day** field.
3. Set the current time in the **Time** field.
4. Press the **RTC** button to confirm your settings.

Java Tool

➔ Select **System Settings > Date and Time** in the task area.

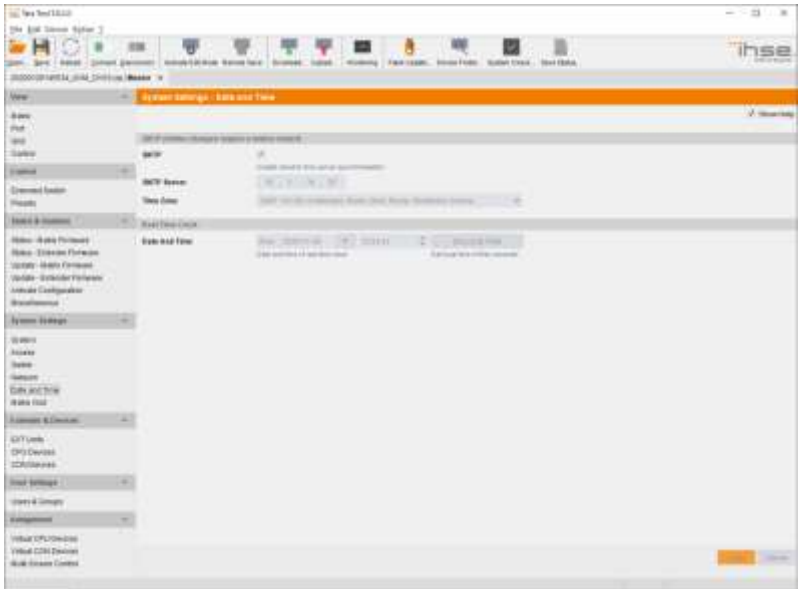

Menu System Settings - Date and Time

In order to configure a time server, proceed as follows:

1. Enable **SNTP** option.
2. Enter the IP address of your SNTP server in the **SNTP Server** field.
3. Select your time zone in the **Time Zone** field.
4. Press the **Apply** button to confirm your settings.
5. Restart the matrix. The system time will be now provided by the SNTP server.

In order to set the real time clock without using SNTP, proceed as follows:

1. Set the current date in the **Date and Time** field.
2. Set the current time in the **Day and Time** field.
3. Press the **Apply** button to set the system time.
4. Option: If you want to receive the time from your currently used computer, press the **Get Local Time** button.

5.5 User Settings

You have the option to configure the following user settings:

5.5.1 User

New users and their user settings and permissions are set in this menu.

You have the following options to access the menu:



You can select the following settings:

Field	Selection	Description
Name	Text	User name (case sensitive) Note: A user name can consist of up to 32 characters.
Password	Text	User password (case sensitive)
Repeat Password	Text	Repeat user password (case sensitive)
Member of Group	Selection	Define the assignment to a user group
Administrator	activated	<ul style="list-style-type: none"> Permission for system configuration and all switching operations User has administrator rights
	deactivated	<ul style="list-style-type: none"> Function not active.
Super User	activated	Permission to switch any console to any CPU in Extended Switching .
	deactivated	Function not active.
Power User	activated	<ul style="list-style-type: none"> User has user rights Permission to switch consoles to CPUs in Extended Switching according to the CON or User ACL, but not in Private Mode.
	deactivated	Function not active.
SNMP User	activated	Permission to use SNMP V3 (encrypted)
	deactivated	Function not active.
Auto Connect	activated	Re-establish the previous user connection after login

Field	Selection	Description
	deactivated	Function not active
AD group locked	activated	Lock synchronization of group attribute for an Active Directory user. This setting is required for a manual change of user groups for a specific Active Directory user.
	deactivated	Function not active (default)

OSD

➔ Select **User Data** in the main menu.

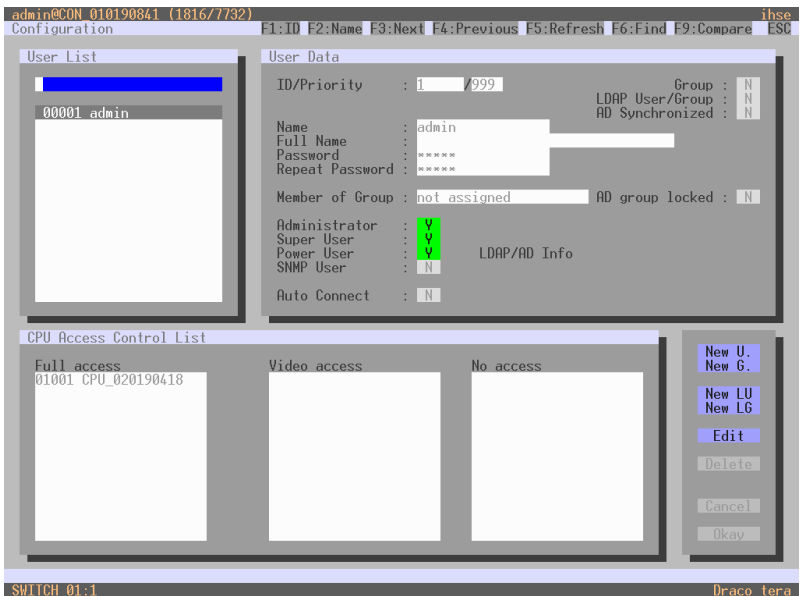

Menu **Configuration - User Data**

You can select the following buttons:

Button	Function
New	Create a new user
Edit	Edit an existing user
Delete	Delete an existing user
Cancel	Reject changes
Save	Save changes

Java Tool

➔ Select **User Settings > Users & Groups** in the task area.

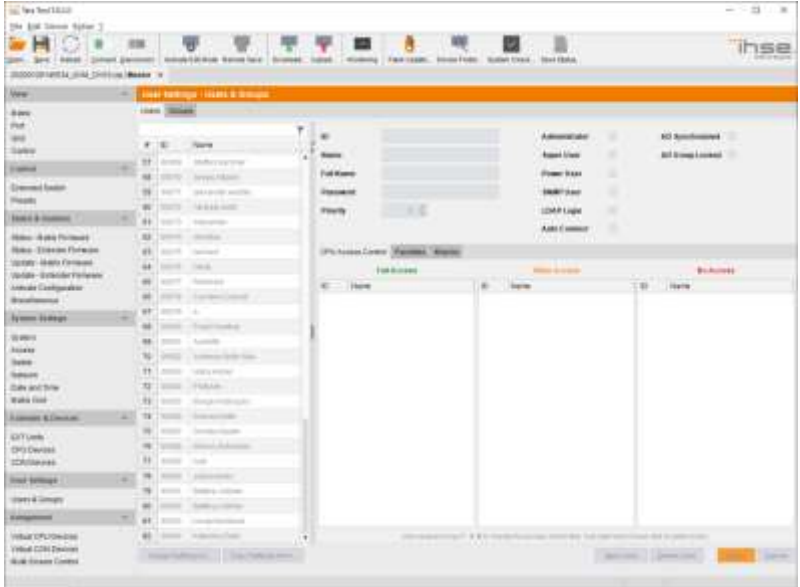

Menu **User Settings - Users & Groups**

You can select the following buttons:

Button	Function
New	Open a new user configuration
Delete	Delete an existing user
Apply	Create a new user account
Cancel	Reject changes

In order to configure a user access rights for CPUs, proceed as follows:

1. Select a user in the **User** list.
2. By clicking the right mouse button once on a CPU in one of the respective access lists (**Full Access**, **Video Access** and **No Access**) two lists for selection will appear in which the respective CPU can be moved and the access rights can be changed.
3. Confirm the configuration with the **Apply** button.

In order to create a new user, proceed as follows:

1. Press the **New User** button.
2. Select a template of an existing user if applicable (**Choose template**).
3. Press the **OK** button.
4. Set a user name.
5. Set a password.
6. Set general access permissions.
7. Set user permissions for CPU access (paste function).
8. Set user favorites for OSD access.
9. Press the **Apply** button to save the new user settings.

You can select the following keyboard commands:

Function	Keyboard Command
Add CPU to list Full Access	<F>
Add CPU to list Video Access	<V>
Add CPU to list No Access	<N>

5.5.2 Favorite List Users

Individual favorite lists of CPUs that will be switched frequently can be created for different users in this menu. A favorite list can contain up to 16 different CPUs.

The switching of the favorites is done via 'Hot Key' using the keyboard (see Chapter 6.1.1, Page 204).

You have the following options to access the menu:



OSD

→ Select **Assignments > User Favorites** in the main menu.

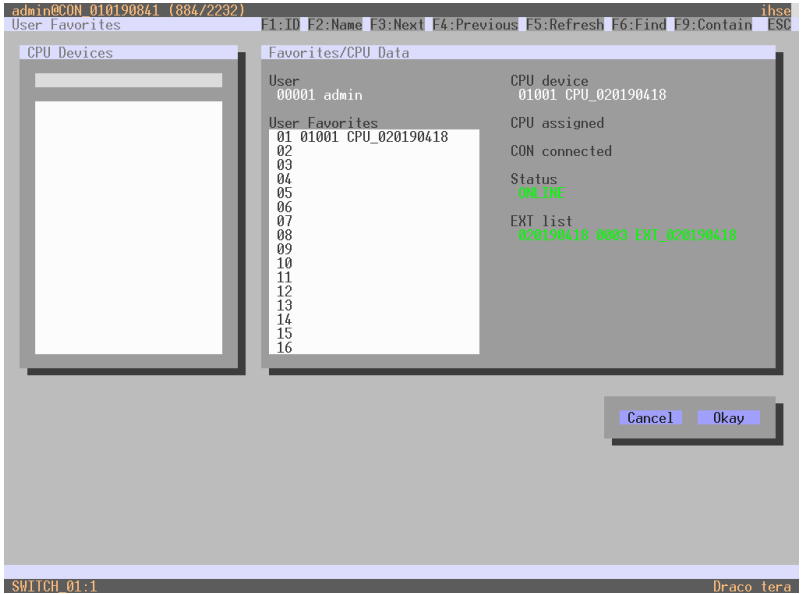

Menu Assignments – User Favorites

To create a favorite list for you own user, proceed as follows:

1. Select a CPU to be moved to the favourite list on the **CPU Devices** list. Press <a> to move a CPU Device to the favourite list. Remove a CPU by pressing <r>.
2. The order of the CPU Devices within the favorite list can be changed by pressing <+> and <->.
3. Press the **Save** button to save the settings.

Java Tool

- ➔ Select **User Settings > Users & Groups** in the working area and select the respective user for the favorite list. Open the **Favorites** tab.

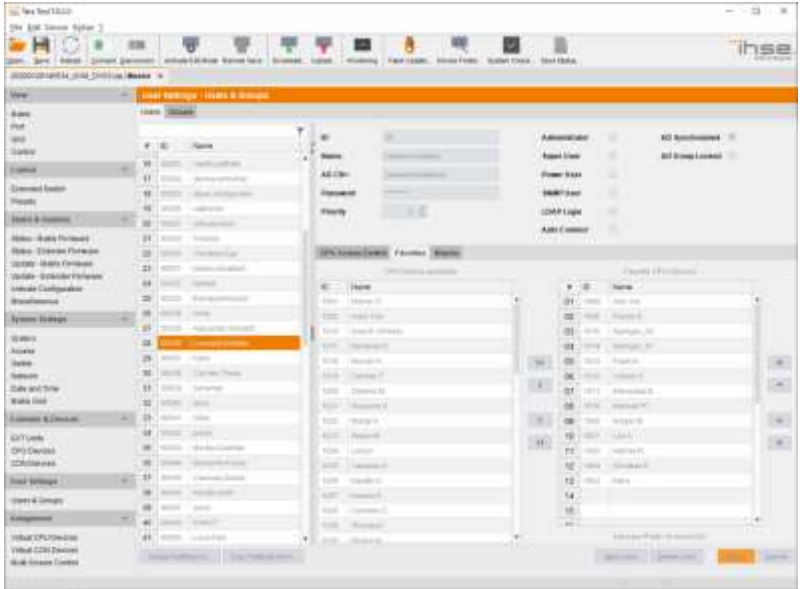

Menu *User Settings - Users & Groups*

To create a favorite list for any user, proceed as follows:

1. Select the CPUs in the **CPU available** list that should be added to the favorite list (**CPU assigned**). By pressing the <Ctrl> at the same time, more than one CPU Device can be marked.
2. Press the > button to move the marked CPU Devices to the favorite list. If you press the >> button, the first eight CPU Devices from the **CPU available** list will be moved to the favorite list (**CPU assigned**).
3. The order of marked CPU Devices within the favorite list can be changed by pressing <+> and <->.
4. In order to remove marked CPU Devices from the favorite list, press the < button. If you press the << button, all CPU Devices will be removed from the favorite list.

5.5.3 User Macros

In this menu macro commands for switching, disconnection or user administration can be created. Macro commands are created for each user separately.

A macro can execute up to 16 switching commands successively.

The execution of the macros is done via 'Hot Key' and the <F1>-<F16> function keys (see Chapter 6.1.3, Page 206).



In order to execute user macros the user has to be logged in to the matrix.

You can select the following settings:

Field	Selection	Description
Function (01–16)	Connect (P1=CON, P2=CPU)	Set bidirectional connection from console P1 to CPU P2
	Connect Video (P1=CON, P2=CPU)	Set video connection from console P1 to CPU P2
	Disconnect (P1=CON)	Disconnect console P1
	Logout User	Logout current user
	Set Real CPU (P1=VCPU, P2=RCPU)	Assign a virtual CPU to a real CPU
	Set Virtual CON (P1=RCON, P2=VCON)	Assign a real console to a virtual console
	Push (P1=CON)	The user's KVM connection is forwarded to console P1 and is changed to a video only connection.
	Push Video (P1=CON)	The video signal of the current connection (KVM or video only) is forwarded to console P1. The user's connection remains unchanged (KVM or video only).

Field	Selection	Description
	Get (P1=CON)	The user's console gets a KVM connection to the CPU that is currently connected to console P1. The connection of console P1 is changed into a video only connection.
	Get Video (P1=CON)	The user's console gets a video only connection to the CPU that is currently connected to console P1. The connection of console P1 remains unchanged (KVM or video only).
	Login User console P2	Login a certain user P1 at console P2
P1	CON or CPU Device	Name of CON or CPU Device
P2	CPU or CPU Device	Name of CON or CPU Device



The macros can also be used to switch to CPU groups.

You have the following options to access the menu:



OSD

- ➔ Select via **Configuration > User Macros** in the main menu the user for which a user macro has to be created.

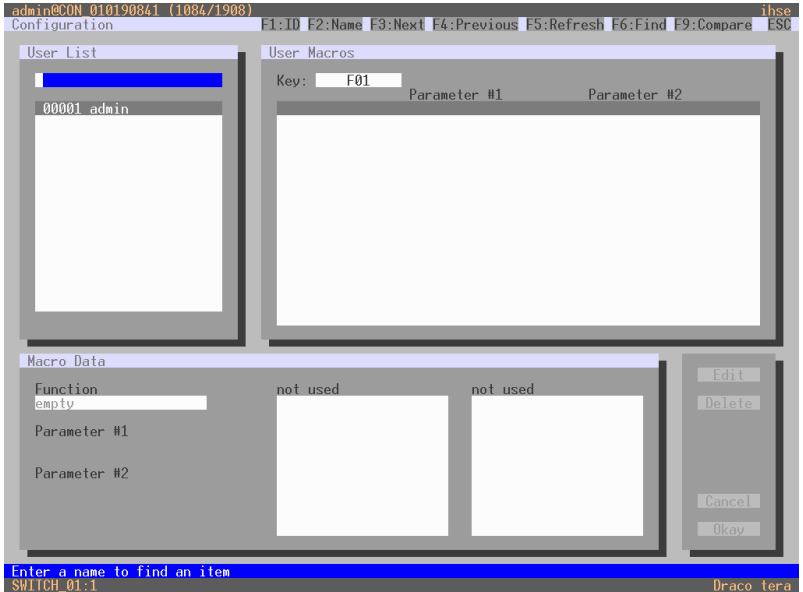

Menu **Configuration – User Macros**

In order to create a macro for the selected user, proceed as follows:

1. Select in the **Key** field the function key for which a macro has to be created.
2. Select the position in the **Key** list where a macro command is to be inserted.
3. Select a macro command in the **Macro Data** field.
4. Set the necessary parameters **P1** and **P2** (e.g. CON Devices or CPU Devices) for the selected macro command.
5. Confirm your selection by pressing <Enter> and repeat the process for further macro commands, if necessary.

Java Tool

- ➔ Select **User Settings > Users & Groups** in the working area and select the user for which macros are to be created. Open the **Macros** tab.

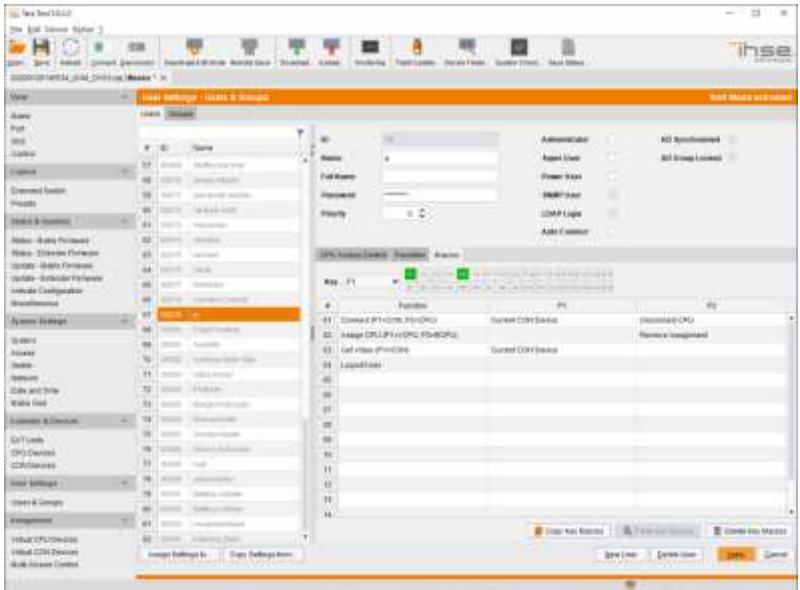

Menu **User Settings – Users & Groups**

In order to create a macro for the selected user, proceed as follows:

1. Select in the **Key** field the function key for which a macro has to be created.
2. Select in the **Function** column the commands that should be part of the macro. The selection list is opened by a double click on the empty fields.
3. Select in the **P1** and **P2** columns the respective parameters for the macro functions (e.g. corresponding consoles and CPUs).
4. Confirm your selections by pressing the **Apply** button.

For an efficient macro configuration the following context functions are available:

- ➔ Via right click on the **Macros** tab, macros can be assigned to other users by using the **Assign Macros to ...** function and can be copied from other users by using the **Copy Macros from ...** function.
- ➔ Via right click on the macro list, macros of the selected key can be copied into the cache by using the **Copy Key Macros** function. You can paste the macros from the cache into a key by using the **Paste Key Macros** function and you can reset all macros of the selected key by using the **Reset Key Macros** function.

5.5.4 User Groups

The KVM matrix allows to bundle the users of a configuration into User Groups. The groups can be used to logically or thematically subdivide the users. As an application example you can group all power users together. The configuration of User Groups at the same times increases the clarity of the configuration.

You have the following options to access the menu:



OSD

To create and configure a User Group, proceed as follows:

1. Select **Configuration > User Data** in the main menu.
2. Press the button **New G..**
3. Enter a group name into the field **Name**.
4. Press the button **Okay**.

The group is created now.

To assign a user to a group, proceed as follows:

1. Select **Configuration > User Data** in the main menu.
2. Select the user you want to assign to a User Group.
3. Select the User Group for the assignment in the field **Member of Group** using the cursor up and down keys.
4. Press the button **Okay**.

The user is assigned to the User Group now.

Java-Tool

To create and configure a User Group, proceed as follows:

1. Select the tab **Groups** in the menu **User Settings > Users & Groups** of the working area.
2. Press the button **New Group**.
A popup window will be opened.
3. Select **Create a standard Group** in the popup window and press **Ok**.
4. Enter a group name into the field **Name**.
5. Press the button **Apply**.
The group is created now.

To assign a user to a group, proceed as follows:

1. Select the tab **Groups** in the menu **User Settings > Users & Groups** of the working area.
2. Select the User Group to be assigned with a user.
3. Select a user in the list **User/Group available** that you want to assigned to the User Group.
4. Move the highlighted user to the list **User/Group assigned**.
5. Press the button **Okay**.
The user is assigned to the User Group now.

5.6 Extender Settings

All extender units are managed in this menu. This includes the creation of new extender units and the deletion of existing extender units.

The extender unit describes the connection of an physical extender to the matrix. Every extender board with a direct cable connection to the matrix is recognized as an extender unit. Dual-Head KVM extenders will be recognized as two independent extender units.



KVM Extenders automatically create extender units inside the matrix.

You have the following options to access the menu:



You can select the following settings:

Field	Selection	Description
ID	Text	Numerical value of the extender ID (KVM extenders: ID is provided by extender unit (Serial No.) and cannot be changed)
Name	Text	Name of the extender unit
Fixed	activated	Create an extender unit with a fixed port assignment (default)
	deactivated	Function not active.
Port	1–288 (depending on the matrix)	Port number of the extender unit

OSD

➔ Select **Configuration > EXT Units** in the main menu.

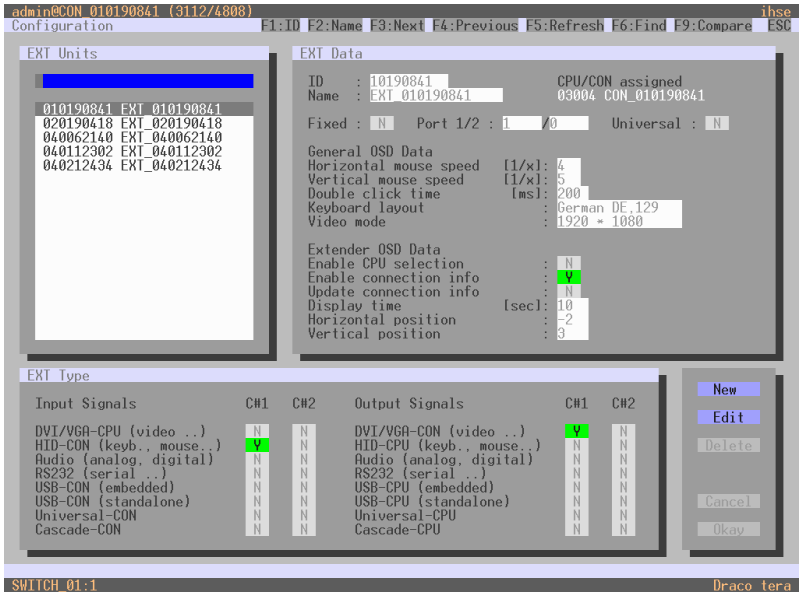

Menu Configuration – EXT Units

You can select the following buttons:

Button	Function
New	Create a new extender unit
Edit	Edit an existing extender unit
Delete	Delete an existing extender unit
Cancel	Reject changes
Save	Save changes

The settings for the tab **General OSD Data** are described in Chapter 5.13.2, Page 146.

Java Tool

➔ Select **Extender & Devices > EXT Units** in the task area.

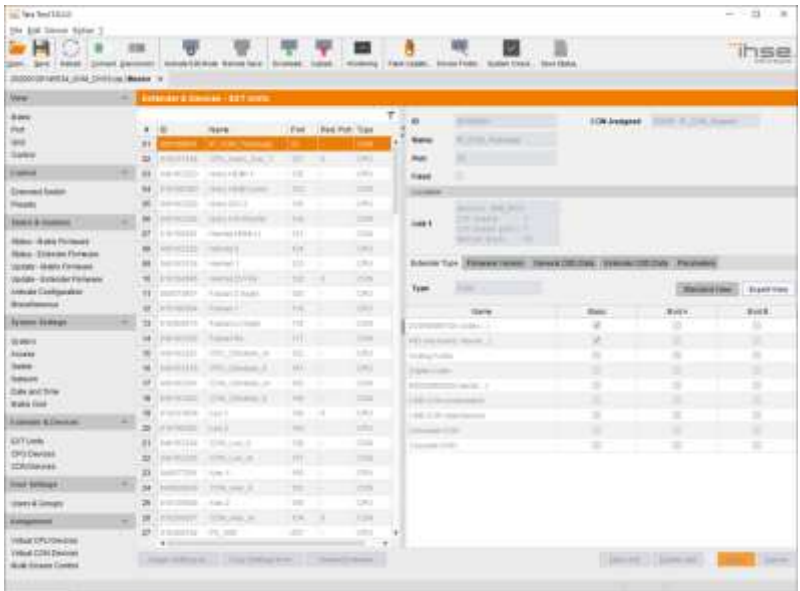

Menu **Extender & Devices - EXT Units**

You can select the following buttons:

Button	Function
New	Create a new extender unit
Delete	Delete an existing unit
Apply	Confirm changes of an extender unit
Cancel	Reject changes

5.6.1 Flex-Port Extender Units

Extenders with auto-ID functionality are automatically recognized and cannot be created manually. This is the Flex Port function of the matrix.



The connection of a fixed port extender unit (e. g. USB 2.0) to a Flex-Port can cause unintended results.

5.7 USB 2.0 Extender

This chapter helps you to configure and use your USB 2.0 extenders. These extenders will have to be connected to standard I/O boards in this case. USB 2.0 extenders can be configured for independent switching or can be assigned to already existing KVM extenders.

You have the following options to configure the extenders:



OSD

➔ Select **Configuration > EXT Units** in the main menu.

The screenshot shows the OSD Configuration menu for EXT Units. The top bar displays the user 'admin@CON' and the device ID '010190841 (3112/4808)'. The menu is divided into several sections:

- EXT Units:** A list of existing units with their IDs and names.
- EXT Data:** Configuration details for the selected unit, including ID, Name, Fixed status, Port 1/2, and Universal status. It also shows General OSD Data (mouse speed, double click time, keyboard layout, video mode) and Extender OSD Data (enable CPU selection, connection info, update connection info, display time, horizontal/vertical position).
- EXT Type:** A table showing input and output signals for the extender.
- Buttons:** New, Edit, Delete, Cancel, and Okay buttons are visible on the right side.

ID	Name	EXT ID
010190841	EXT_010190841	010190841
020190418	EXT_020190418	020190418
040062140	EXT_040062140	040062140
040112302	EXT_040112302	040112302
040212434	EXT_040212434	040212434

Input Signals	C#1	C#2	Output Signals	C#1	C#2
DVI/VGA-CPU (video ..)	N	N	DVI/VGA-COM (video ..)	N	N
HID-COM (keyb., mouse..)	Y	N	HID-CPU (keyb., mouse..)	Y	N
Audio (analog, digital)	N	N	Audio (analog, digital)	N	N
RS232 (serial ..)	N	N	RS232 (serial ..)	N	N
USB-COM (embedded)	N	N	USB-CPU (embedded)	N	N
USB-COM (standalone)	N	N	USB-CPU (standalone)	N	N
Universal-COM	N	N	Universal-CPU	N	N
Cascade-COM	N	N	Cascade-CPU	N	N

Menu Configuration – EXT Units

1. In order to configure a USB 2.0 extender unit, press the **New** button. An extender with an eight-digit ID will be created, starting with digit **9**.
2. Assign an appropriate name to the extender in the **Name** field.
3. Enter the port number of the matrix physically connected to the USB 2.0 extender unit into the **Port** field.

4. In order to configure the created extender as a CON Unit, set the **USB-CON (standalone)** option to **Y (C#1)** in the **Input Signals** column).
5. Confirm the setting by pressing the **Okay** button.
6. In order to configure the created extender as a CON Unit, set the **USB-CPU (standalone)** option to **Y (C#1)** in the **Output Signals** column).
7. Confirm the setting by pressing the **Okay** button.
8. In order to create an individually switchable Device for the USB 2.0 CON extender, select **Configuration > CON Devices** and press the **New R** button.
Alternatively, you can assign the USB 2.0 CON extender to an already existing CON Device. For this purpose, select the Device and move the USB 2.0 CON extender from the **EXT available** field into the **EXT assigned** field.
9. Give an appropriate name to the new Device in the **Name** field.
10. Repeat the steps 8 and 9 for all USB 2.0 CPU extenders in the **Configuration > CPU Devices** menu.
11. If you use parallel operation within the matrix, set the **Release Time** in the **Configuration > Switch** menu to **10 s** or more (see Chapter 5.13.6, Page 158).
12. Restart all I/O boards on which USB 2.0 extenders have been configured or alternatively restart the matrix.
The USB 2.0 extender are now configured and can be used.

Java Tool

➔ Select **Extender & Devices > EXT Units** in the task area.

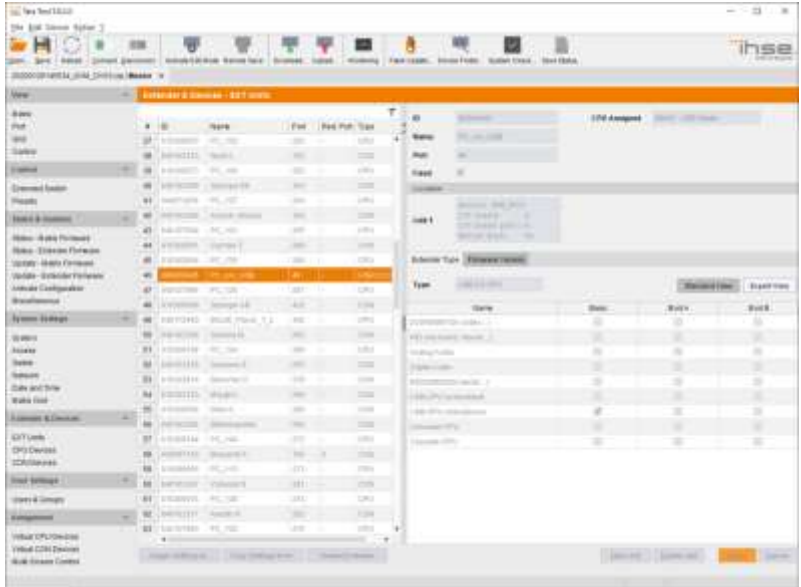

*Menu **Extender & Devices - EXT Units***

1. Press the **New Unit** button.
A popup window opens.
2. Select **Choose template** in the selection box, if you want to use a template for a USB 2.0 CON Unit (**USB CON Unit**) or a USB 2.0 CPU Unit (**USB CPU Unit**).
An extender with an eight-digit ID will be created, starting with digit **9**.
3. Give an appropriate name to the extender in the **Name** field.
4. Enter the port number of the matrix physically connected to the USB 2.0 extender unit into the **Port** field.
5. Confirm your settings by pressing the **Apply** button.
6. The USB 2.0 CON extenders now has to be either assigned to an existing CON Device in the menu **Extender & Devices > CON Devices** or a new CON Device has to be created for the assignment by pressing the **New Device** button.

7. The USB 2.0 CPU extenders now has to be either assigned to an existing CON Device in the **Extender & Devices > CPU Devices** menu or a new CON Device has to be created for the assignment by pressing the **New Device** button.
8. If you use parallel operation within the matrix, set the **Release Time** in the **System Settings > Switch** menu to **10 s** or more (see Chapter 5.13.6, Page 158).
9. Restart all I/O boards on which USB 2.0 extenders have been configured or alternatively restart the matrix.

The USB 2.0 extenders are now configured and can be used.



Created extender units are always set as fixed port extenders. This configuration is necessary if you want to switch e.g. USB 2.0 connections via the matrix.

In order to make a fixed port available again for Flex-Port extender units after deleting a fixed port extender unit, a restart of the I/O board is necessary.

5.8 Extenders for UNI I/O Boards (USB 2.0 / USB 3.0)

This chapter will help you to configure and use your USB 2.0/3.0 extenders. For the use of USB 3.0 extenders you need at least one UNI I/O board and SFP modules based on 6.25 Gbit/s for the matrix.

You have the following options to configure the system:



OSD

➔ Select **Configuration > EXT Units** in the main menu.

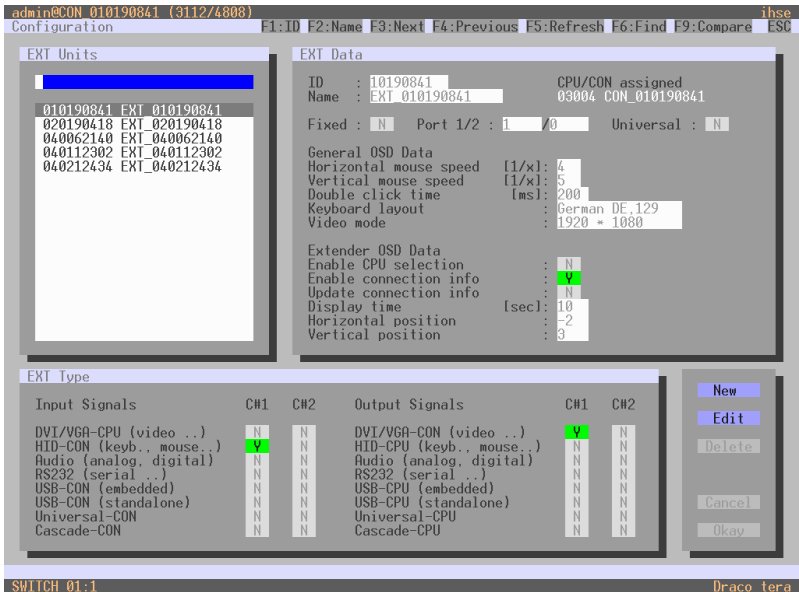

Menu Configuration – EXT Units

1. Insert the SFP modules into the matrix and connect the extenders according to the required application.
One extender will be created for each SFP module in the **EXT Units** list. The appropriate names always start with "UNI".
2. In order to configure a CON Unit, select one of the extenders in the **EXT Units** list that are physically connected to a USB CON Unit.
3. Edit the extender by setting the **USB-COM (standalone)** option in the **Input Signals** field to **Y** for **C#1**. Set additionally the **Universal-CPU** option in the **Output Signals** field to **N** for **C#1**.
4. In order to configure a CPU Unit, select one of the extenders in the **Ext Units** list that are physically connected to a USB CPU Unit.
5. Edit the extender by setting the **USB-CPU (standalone)** option in the **Output Signals** field to **Y** for **C#1**. Set additionally the **Universal-CPU** option in the **Input Signals** field to **N** for **C#1**.

6. The edited EXT Units for the respecting USB CON Units now have to be either assigned to an existing CON Device or you have to create a new CON Device by using the **New R.** button for an assignment in the **Configuration > CON Devices** menu.
7. The edited EXT Units for the respecting USB CPU Units now have to be either assigned to an existing CPU Device or you have to create a new CPU Device by using the **New R.** button for an assignment in the **Configuration > CPU Devices** menu.
8. If you use parallel operation within the matrix, set the **Release Time** in the **Configuration > Switch** menu to **10 s** or more (see Chapter 5.13.6, Page 158).
9. Restart the matrix.
The USB extenders are completely configured now and can be used.

Java-Tool

➔ Select **Extender & Devices > EXT Units** in the task area.

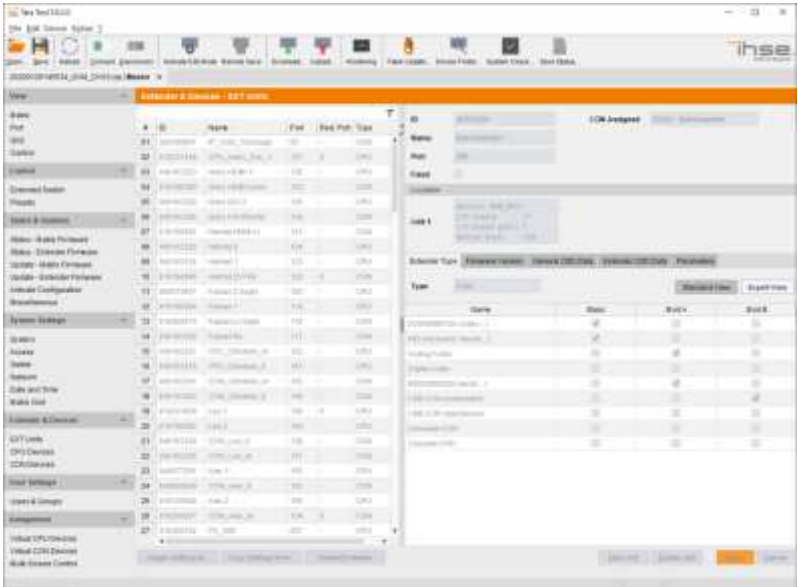

Menu **Extender & Devices - EXT Units**

1. Insert the SFP modules into the matrix and connect the extender according to the required application.
One extender will be created for each SFP module in the **Ext Units** list. The appropriate names always start with "UNI".
2. In order to configure a CON Unit, select one of the extenders in the **Ext Units** list that are physically connected to a USB CON Unit.
3. Select the item **UNI CON USB** in the **Type** selection box of the **Extender Type** tab and confirm your settings by pressing the **Apply** button.
4. Restart the I/O board upon request in the popup window by pressing the **Yes** button.
5. In order to configure a CPU Unit, select one of the extenders in the **Ext Units** list that are physically connected to a USB CPU Unit.
6. Select the item **UNI CPU USB** in the **Type** selection box of the **Extender Type** tab and confirm your settings by pressing the **Apply** button.
7. Restart the I/O board upon request in the popup window by pressing the **Yes** button.
8. The edited EXT Units for the respecting USB CON Units now have to be either assigned to an existing CON Device or you have to create a new CON Device by using the **New Device** button for an assignment in the **Extender & Devices > CON Devices** menu.
9. The edited EXT Units for the respecting USB CPU Units now have to be either assigned to an existing CPU Device or you have to create a new CPU Device by using the **New Device** button for an assignment in the **Extender & Devices > CON Devices** menu.
10. If you use parallel operation within the matrix, set the **Release Time** in the **System Settings > Switch** menu to **10 s** or more (see Chapter 5.13.6, Page 158).

The USB extenders are completely configured now and can be used.

5.9 Configuration of SDI

This chapter will help you to configure the matrix for the use of SDI. Using SDI requires at least one I/O board and appropriate SFP modules according to the SDI video signal to be used.

You have the following options to configure the system:



OSD

➔ Select **Configuration > EXT Units** in the main menu.

The screenshot shows the 'EXT Units' configuration screen. At the top, it displays the user 'admin@CON_010190841 (3112/4808)' and the current menu 'Configuration'. Below this, there are function keys: F1:ID, F2:Name, F3:Next, F4:Previous, F5:Refresh, F6:Find, F9:Compare, and ESC.

The main area is split into two panes. The left pane, titled 'EXT Units', shows a list of units:

010190841	EXT_010190841
020190418	EXT_020190418
040062140	EXT_040062140
040112302	EXT_040112302
040212434	EXT_040212434

The right pane, titled 'EXT Data', shows configuration for the selected unit 'EXT_010190841':

- ID: 010190841
- Name: EXT_010190841
- CPU/CON assigned: 03004 CON_010190841
- Fixed: N
- Port 1/2: 1 / 0
- Universal: N

General OSD Data:

- Horizontal mouse speed [1/x]: 4
- Vertical mouse speed [1/x]: 5
- Double click time [ms]: 200
- Keyboard layout: German DE_129
- Video mode: 1920 * 1080

Extender OSD Data:

- Enable CPU selection: N
- Enable connection info: Y
- Update connection info: N
- Display time [sec]: 10
- Horizontal position: -2
- Vertical position: 3

The bottom section, 'EXT Type', contains two tables:

Input Signals	CH1	CH2	Output Signals	CH1	CH2
DVI/VGA-CPU (video ..)	<input type="checkbox"/> N	<input type="checkbox"/> N	DVI/VGA-CON (video ..)	<input checked="" type="checkbox"/> Y	<input type="checkbox"/> N
HID-CON (keyb., mouse..)	<input checked="" type="checkbox"/> Y	<input type="checkbox"/> N	HID-CPU (keyb., mouse..)	<input type="checkbox"/> N	<input type="checkbox"/> N
Audio (analog, digital)	<input type="checkbox"/> N	<input type="checkbox"/> N	Audio (analog, digital)	<input type="checkbox"/> N	<input type="checkbox"/> N
RS232 (serial ..)	<input type="checkbox"/> N	<input type="checkbox"/> N	RS232 (serial ..)	<input type="checkbox"/> N	<input type="checkbox"/> N
USB-CON (embedded)	<input type="checkbox"/> N	<input type="checkbox"/> N	USB-CPU (embedded)	<input type="checkbox"/> N	<input type="checkbox"/> N
USB-CON (standalone)	<input type="checkbox"/> N	<input type="checkbox"/> N	USB-CPU (standalone)	<input type="checkbox"/> N	<input type="checkbox"/> N
Universal-CON	<input type="checkbox"/> N	<input type="checkbox"/> N	Universal-CPU	<input type="checkbox"/> N	<input type="checkbox"/> N
Cascade-CON	<input type="checkbox"/> N	<input type="checkbox"/> N	Cascade-CPU	<input type="checkbox"/> N	<input type="checkbox"/> N

On the right side of the 'EXT Type' section, there are buttons: 'New', 'Edit', 'Delete', 'Cancel', and 'Okay'. At the bottom of the screen, it shows 'SWITCH 01:1' and 'Draco tera'.

Menu Configuration - EXT Units

1. Insert the SFP modules into the matrix.
One extender will be created for each SFP module in the **EXT Units** list. The appropriate names always start with "UNI".
2. In order to configure a SDI input select one of the extenders in the **EXT Units** list that corresponds to the respective SFP and is intended to be used as input.

3. Edit the extender by setting the **Universal-CPU** option in the Output Signals field to **Y** for **C#1**. Set additionally the **Universal-CON** option in the Input Signals field to **N** for **C#1**.
4. In order to configure a SDI output select one of the extenders in the **EXT Units** list that corresponds to the respective SFP and is intended to be used as output.
5. Edit the extender by setting the **Universal-CON** option in the Input Signals field to **Y** for **C#1**. Set additionally the **Universal-CPU** option in the Output Signals field to **N** for **C#1**.
6. The edited EXT Units for the SDI inputs now have to be either assigned to an existing CPU Device or you have to create anew CPU Device by using the **New R.** button for an assignment in the **Configuration > CPU Devices** menu.
7. The edited EXT Units for the SDI outputs now have to be either assigned to an existing CON Device or you have to create a new CON Device by using the **New R.** button for an assignment in the **Configuration > CON Devices** menu.
8. Restart the Matrix.
The SDI inputs and outputs are completely configured now and can be used.

Java-Tool

➔ Select **Extender & Devices > EXT Units** in the task area.

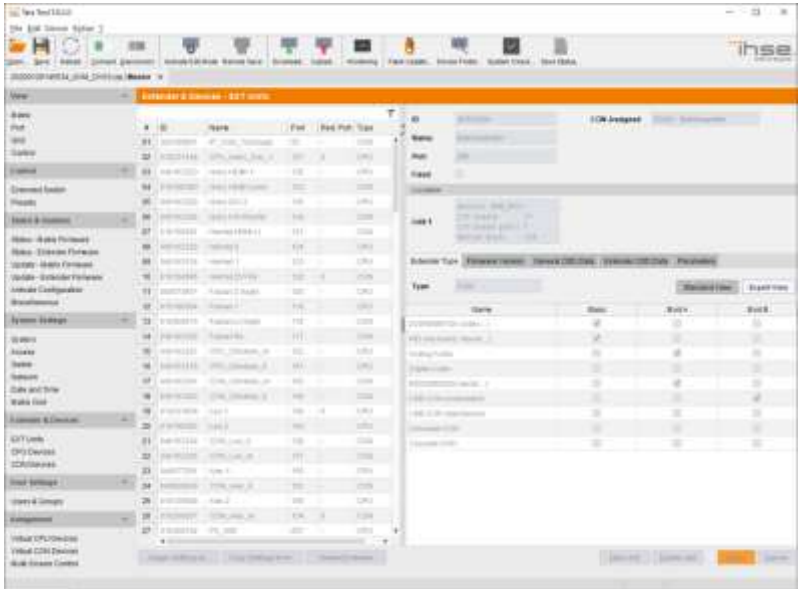

Menu **Extender & Devices - EXT Units**

1. Insert the SFP modules into the matrix.
One extender will be created for each SFP module in the **EXT Units** list. The appropriate names always start with "UNI".
2. In order to configure a SDI input select one of the extenders in the **EXT Units** list that corresponds to the respective SFP and is intended to be used as input.
3. Select the item **UNI CPU** in the Type selection box of the **Extender Type** tab and confirm your settings by pressing the **Apply** button.
4. Restart the I/O board upon request in the popup window by pressing the **Yes** button.
5. In order to configure a SDI output select one of the extenders in the **EXT Units** list that corresponds to the respective SFP and is intended to be used as output.
6. Select the item **UNI CON** in the **Type** selection box of the **Extender Type** tab and confirm your settings by pressing the **Apply** button.

7. Restart the I/O board upon request in the popup window by pressing the **Yes** button.
8. The edited EXT Units for the SDI inputs now have to be either assigned to an existing CPU Device or you have to create a new CPU Device by using the **New Device** button for an assignment in the **Extender & Devices > CPU Devices** menu.
9. The edited EXT Units for the SDI outputs now have to be either assigned to an existing CON Device or you have to create a new CON Device by using the **New Device** button for an assignment in the **Extender & Devices > CON Devices** menu.

The SDI inputs and outputs are completely configured now and can be used.

5.10 CPU Settings

New CPU Devices are configured in this menu including their assignment to extenders.

The assignment helps to describe and switch more complex computer configurations (e.g. Quad-Head with USB 2.0) in the matrix.

You have the following options to access the menu:



You can select the following settings:

Field	Selection	Description
ID	Text	ID of the CPU Unit (see Chapter 5.4.2, Page 88).
Member of Group	Selection	Assign the CPU Device to a group.
Member of Switch	Selection	Assign a CPU Device for a CPU Switch to the respective CPU Switch.
Name	Text	Name of the CPU Device.
Virtual Device	activated	Create new CPU Device as a virtual one.
	deactivated	Function not active (default).
Allow Private	activated	Allow switching to the respective CPU Device in Private Mode

Field	Selection	Description
	deactivated	Function not active (default).
Force Private	activated	Force switching to the respective CPU only in Private Mode.
	deactivated	Function not active (default).
Fix Frame Color	Selection list	Force showing a colored frame when switching to the respective CPU. You can select between 7 colors.
Reference	activated	Activate a reference CPU Device that inherits both Device and extender settings to any CPU Unit that is connected to the matrix for the first time. Note: It is recommended to activate the reference setting for one single CPU Device only.
	deactivated	Function not active (default).
2 Step Access	activated	Open a pop-up window after switching to the particular CPU Device. In the background a Video Only connection will be established. It requires a confirmation in the pop-up window to establish a Full Access connection to the CPU Device.
	deactivated	Function not active (default).
CPU Colors	Selection list	The CPU Device name will be highlighted according to the color setting for text and background. You can select between 16 colors.
Exclusive Access	activated	Activate an access limitation for the case that a CPU Device is already connected via Full Access connection. When having the same priorities, any additional access to the CPU Device can only be established with a Video Only connection. Having a lower priority any additional connection is not possible. Only when having a higher priority, an additional Full Access connection can be established and and K/M control can be taken over.
	deactivated	Function not active (default).

OSD

➔ Select **Configuration > CPU Units** in the main menu.

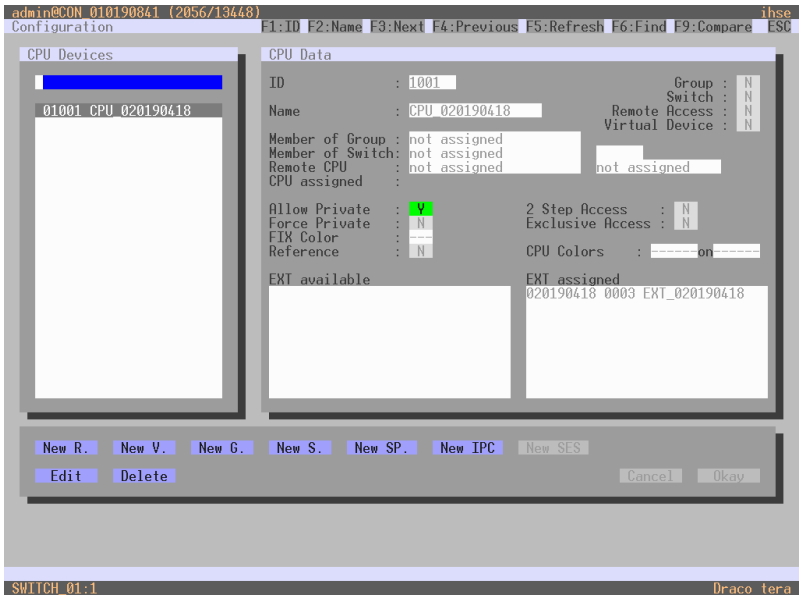

Menu **Configuration – CPU Devices**

You can select the following buttons:

Button	Function
New R.	Create a new real CPU Device
New V.	Create a new virtual CPU Device
New G.	Create a new CPU Group
New S.	Create a new CPU Switch (484 series)
New SP.	Create a CPU for a CPU Switch
Edit	Edit an existing CPU Device
Delete	Delete an existing CPU Device
Cancel	Reject changes
Save	Save changes

Java Tool

➔ Select **Extender & Devices > CPU Devices** in the task area.

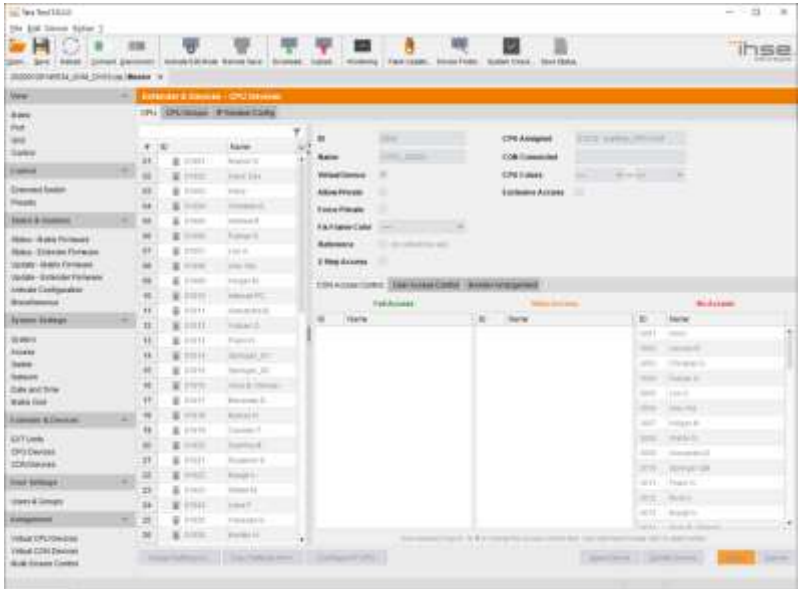

Menu **Extender & Devices - CPU Devices**

You can select the following buttons:

Button	Function
New	Open a new CPU Device
Delete	Delete a new CPU Device
Apply	Confirm a created CPU Device
Cancel	Reject changes
>	Assign selected extender units
>>	Assign all available extender units
<	Remove selected extender units
<<	Remove all extender units

You can select the following keyboard commands:

Function	Keyboard Command
Change assignment number of EXT unit upwards	<+>
Change assignment number of EXT unit downwards	<->

In order to create a new CPU Device, proceed as follows:

1. Press the **New Device** button.
2. Select a real CPU (**Create a standard CPU**) or a virtual CPU (**Create a virtual CPU**) or a template of an existing CPU (**Choose template**).



A template can only be used if there is at least one existing CPU Device.

3. Press the **OK** button.
4. Determine all parameters that are relevant for the CPU.
5. To confirm the new CPU, press the **Apply** button.

In order to access a new CPU via matrix, an assignment of one or more CPU type extender units is required. Proceed as follows:

1. Select the new CPU in the **CPU Devices** list.
2. Select one or more extenders in the **Extender available** list.
3. Perform the assignment by pressing the **>** button. To assign all available extenders to the CPU, press the **>>** button.
The assignments are displayed in the **Extender assigned** list.
4. Confirm the assignment by pressing the **Apply** button.

In order to remove an extender assignment, proceed as follows:

1. Select a CPU in the **CPU Devices** list.
2. Select one or more extenders in the **Extender assigned** list.
3. Remove the assignment with the **<** button. To remove all existing assignments, press the **<<** button.
4. Confirm the removal with the **Apply** button.

5.11 CPU Groups

The KVM matrix allows to bundle the CPU Devices of a configuration into CPU groups. The groups can be used to logically or thematically subdivide the CPU Devices. As an application example you can group all CPU Devices together that are connected to a specific matrix in a matrix grid. The configuration of CPU groups at the same times increases the clarity of the configuration.

You have the following options to configure CPU groups:



OSD

To create and configure a CPU Group, proceed as follows:

1. Select **Configuration > CPU Devices** in the main menu.
2. Press the button **New G..**
3. Enter a group name into the field **Name**.
4. Press the button **Okay**.

The group is created now.

To assign a CPU Device to a group, proceed as follows:

1. Select **Configuration > CPU Devices** in the main menu.
2. Select the CPU Device you want to assign to a CPU group.
3. Select the CPU Group for the assignment in the field **Member of Group** using the cursor up and down keys.
4. Press the button **Okay**.

The CPU Device is assigned to the CPU Group now.

Java Tool

To create and configure a CPU Group, proceed as follows:

1. Select the tab **CPU Groups** in the menu **Extender & Devices > CPU Devices** of the working area.
2. Press the button **New Group**.
A popup window will be opened.
3. Select **Ok** in the popup window or select a template from an existing group (**Choose template**).
4. Enter a group name into the field **Name**.
5. Press the button **Apply**.
The group is created now.

To assign a CPU Device to a group, proceed as follows:

1. Select the tab **CPU Groups** in the menu **Extender & Devices > CPU Devices** of the working area.
2. Select the CPU Group to be assigned with a CPU Device.
3. Select a CPU Device in the list **CPU/Group available** that you want to assign to the CPU Group.
4. Move the highlighted CPU Device to the list **CPU/Group assigned**.
5. Press the button **Okay**.
The CPU Device is assigned to the CPU Group now.

5.12 Configuration CPU Switch (484 Series)

The CPU Switch (484 Series) can be specifically configured for a use with a KVM matrix. The configuration allows to individually switch the up to eight input signals via OSD.

You have the following possibility to configure the CPU Switch:



OSD

To configure the CPU Switch for an individual switching of the single inputs, proceed as follows:

1. Select **Configuration > CPU Devices** in the main menu.
2. Press the button **New S..**
A new CPU Switch will be created.
3. Enter a CPU Switch name into the field **Name**.
4. Assign an EXT Unit to the CPU Switch into the field **EXT assigned**.
5. Press the button **New SP..**
A new CPU (input) for a CPU Switch will be created (Port 1).
6. Assign the created CPU (5.) to a CPU switch in the field **Member of Switch**.
7. Repeat the steps 5. and 6. for each input port in use at the CPU Switch.
8. Press the button **Okay**.
The CPU Switch is now configured and can be individually switched via OSD.

5.13 Console Settings

You have the option to perform the following console settings:

5.13.1 CON Devices

New CON Devices are created in this menu including access rights and assignment to extenders.

You have the following options to access the menu:



You can select the following settings:

Field	Selection	Description
ID	Text	ID of the CON Unit (see Chapter 5.4.2, Page 88).
Priority	0-999	Priority of the CON Device. Note: There is no K/M sharing between CON Devices with a different priority and the release time does not come into account. CON Devices only have Video Only access to a CPU Device, if a CON Device with a higher priority is already switched to it.
Name	Text	Name of the CON Device.
Show Macro List	activated	Show the macro list instead of the CPU selection list.
	deactivated	Function not active (default).
Virtual Device	activated	Create new CON Device as a virtual one.
	deactivated	Function not active (default).
Allow User ACL	activated	Allow activation of the User ACL at the local console.
	deactivated	Function not active (default).
Force Login	activated	Force user login at this CON Device.
	deactivated	Function not active (default).

Field	Selection	Description
LOS Frame	activated	<ul style="list-style-type: none"> When the video signal between source (computer, CPU) and the CPU Unit or the connection between matrix and the CON Unit is lost, an orange frame will be displayed. When switching to a CPU without video signal, a blank screen will appear surrounded by an orange frame.
	deactivated	Function not active (default).
Disable OSD	activated	Disable OSD access for the respective CON Device.
	deactivated	Function not active (default).
Allow CPU Scan	activated	Allow a scan mode with an automatic change of the video signal for the favorite list (CPU Devices) of the respective console or a logged in user.
	deactivated	Function not active (default).
Force CPU Scan	activated	Force a scan mode with an automatic change of the video signal for the favorite list (CPU Devices) of the respective console or a logged in user. Note: An active scanner can be stopped by a mouse or keyboard event. You gain Full Access for the currently switched CPU Device, if Force Connect is activated.
	deactivated	Function not active (default).
Scan Time	0-99 seconds	Retention period until switching to the next CPU Device.
Port Mode	activated	The favorite list will be replaced by a port list where the ports from 1-999 can be directly selected at each matrix or Matrix Grid. Note: The selection only works for CPU Devices and has to be made according to the switching of favorites. When using the Port Mode, CON and User favorites will be deactivated.
	deactivated	Function not active (default).

Field	Selection	Description
Redundancy Off	activated	Function is not active.
	deactivated	Automatically switch to the second link of a connected redundant CON Unit when losing the primary link of a CPU Unit (default).
Reference	activated	Activate a reference CON Device that inherits both Device and extender settings to any CON Unit that is connected to the matrix for the first time Note: It is recommended to activate the reference setting for one single CON Device only
	deactivated	Function not active (default).
CPU Colors	Selection list	The CPU Device name will be highlighted according to the color setting for text and background. You can select between 16 colors.
Fix Frame Color	Selection list	Show a colored frame at the CPU Device. You can select between 7 colors. The colored frame of the CPU device is displayed with priority.

OSD

→ Select **Configuration > CON Devices** in the main menu.

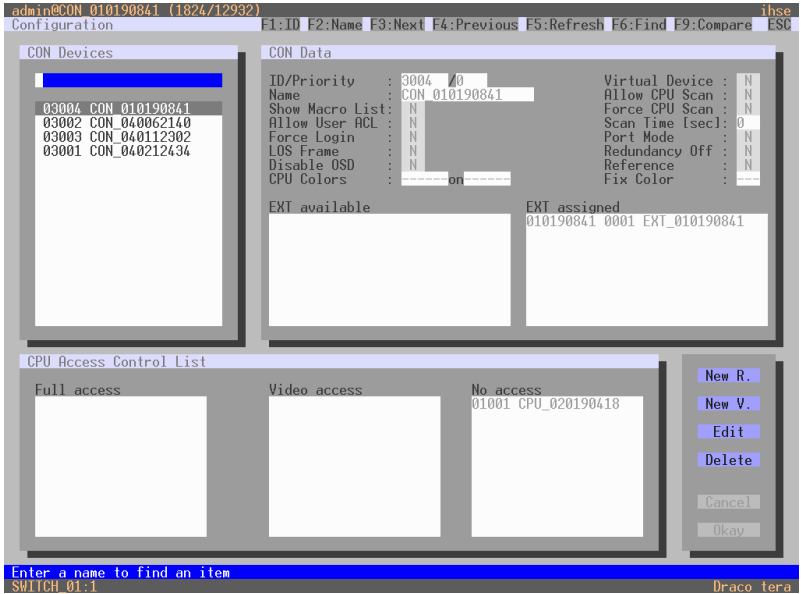

Menu Configuration – CON Devices

You can select the following buttons:

Button	Function
New R.	Create a real console
New V.	Create a virtual console
Edit	Edit an existing console
Delete	Delete an existing console
Cancel	Reject changes
Save	Save changes

Java Tool

➔ Select **Extender & Devices > CON Devices** in the task area.

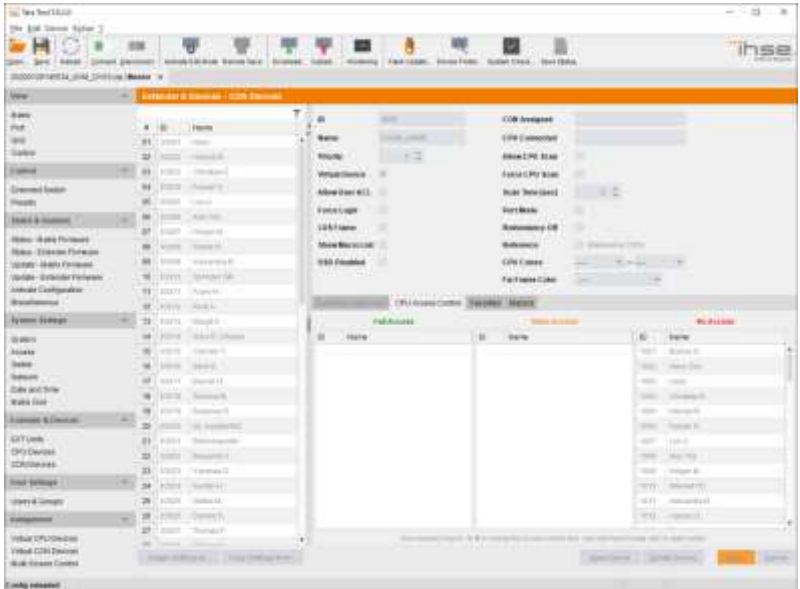

Menu Extender & Devices - CON Devices

You can select the following buttons:

Button	Function
New	Open a new CON Device
Delete	Delete a new CON Device
Apply	Confirm a created CON Device
Cancel	Reject changes
>	Assign selected extender units
>>	Assign all available extender units
<	Remove the selected extender units
<<	Remove all extender units

You can select the following keyboard commands:

Function	Keyboard Command
Decrease assignment number of the extender unit	<+>
Increase assignment number of the extender unit	<->

In order to create a new console, proceed as follows:

1. Press the **New Device** button.
2. Select a real console (**Create a real Console**) or a virtual console (**Create a virtual Console**) or a template of an existing console (**Choose template**).



A template can only be used, if there is at least on existing CON Device.

3. Press the **OK** button.
4. Determine all parameters that are relevant for the console.
5. To confirm a created console, press the **Apply** button.

To run a CPU via a matrix, one or more CON Units (extender) must be assigned. To place an assignment, proceed as follows:

1. Select the console in the **CON Devices** list that has to be assigned to an extender.
2. Select the extender in the **Extender available** list that should be assigned to the CON.
3. Perform the assignment by pressing the > button. To assign all available extenders to the console, press the >> button. The assignments are displayed in the **Extender assigned** list.
4. Confirm the assignment by pressing the **Apply** button.

In order to remove an extender assignment, proceed as follows:

1. Select the console in the **CON Devices** list to be modified.
2. Select the extender(s) in the **Extender assigned** list to be removed.
3. Remove the assignment with the < button. To remove all existing assignments, press the << button.
4. Confirm the changes by pressing the **Apply** button.

In order to configure CPU access rights of consoles, proceed as follows:

1. Select a console in the **CON Devices** list.
2. Open the **CPU Access Control** tab.
3. Assign new access rights by using the right mouse button or the respective keyboard commands (cf. below).
4. Confirm the configuration by pressing the **Apply** button.

You can select the following keyboard commands:

Function	Keyboard Command
Add CPU to list Full Access	<F>
Add CPU to list Video Access	<V>
Add CPU to list No Access	<N>

5.13.2 Mouse and Keyboard

The OSD configuration for mouse and keyboard is made in this menu.

You have the following options to access the menu:



You can select the following settings:

Field	Selection	Description
Hor. Speed 1/x	1–9	Adjustment of the horizontal mouse speed, 1 = slow, 9 = fast (default value: 4)
Ver. Speed 1/x	1–9	Adjustment of the vertical mouse speed, 1 = slow, 9 = fast (default value: 5)
Double Click	100–800	Adjustment of the time slot for a double click (default value: 200 ms)
Keyboard layout	Region	Set the OSD keyboard layout according to the used keyboard (default: German (DE))
Video Mode	Variable or specific resolution	Resolution that is used when opening OSD



The mouse and keyboard settings are console specific and can be set separately for each console.

OSD

➔ Select **Configuration > EXT Units** in the main menu.

The screenshot shows the OSD Configuration menu with the following sections:

- EXT Units:** A list of units including 010190841, 020190418, 040062140, 040112302, and 040212434.
- EXT Data:** Settings for the selected unit (010190841), including CPU/CON assigned (03004 CON_010190841), Fixed status (N), Port 1/2 (1/0), and Universal status (N). It also shows General OSD Data (Horizontal mouse speed, Vertical mouse speed, Double click time, Keyboard layout, Video mode) and Extender OSD Data (Enable CPU selection, Enable connection info, Update connection info, Display time, Horizontal position, Vertical position).
- EXT Type:** A table mapping Input Signals to Output Signals.

Input Signals	C#1	C#2	Output Signals	C#1	C#2
DVI/VGA-CPU (video ..)	N	N	DVI/VGA-CON (video ..)	V	N
HID-CON (keyb., mouse..)	V	N	HID-CPU (keyb., mouse..)	N	N
Audio (analog, digital)	N	N	Audio (analog, digital)	N	N
RS232 (serial ..)	N	N	RS232 (serial ..)	N	N
USB-CON (embedded)	N	N	USB-CPU (embedded)	N	N
USB-CON (standalone)	N	N	USB-CPU (standalone)	N	N
Universal-CON	N	N	Universal-CPU	N	N
Cascade-CON	N	N	Cascade-CPU	N	N

Buttons on the right: New, Edit, Delete, Cancel, Okay.

Footer: Enter a name to find an item, SWITCH 01:1, Draco Tera

Menu Configuration – EXT Units

You can select the following buttons:

Button	Function
Cancel	Reject changes
Save	Save changes

Java Tool

➔ Select **Extender & Devices > EXT Units** in the task area.



Mouse and keyboard settings are made in the **OSD Data** tab.

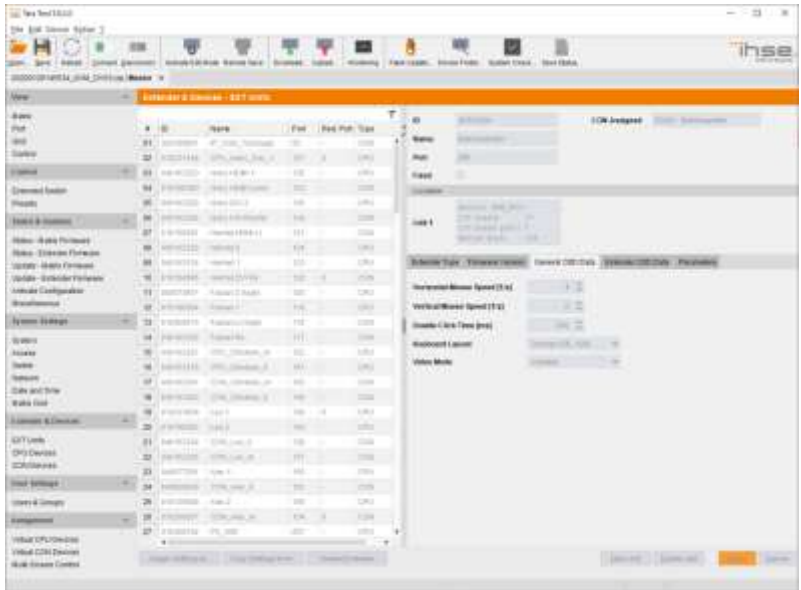

Menu **Extender & Devices - EXT Units**

5.13.3 Extender OSD

In this menu the settings for the Extender OSD can be adjusted. These are local settings that can be made individually for each console.

You can select the following Extender OSD settings:

Field	Selection	Description
Enable CPU Selection List	activated	When executing the key sequence for opening the OSD, a selection list for switching CPU Devices will be displayed in the center of the monitor. Pressing the <F7> button within the selection list opens the standard OSD.
	deactivated	Function not active (default)
Enable Connection Info	activated	Enable Extender OSD (default: YES)
	deactivated	Function not active
Update Connection Info	activated	Update connection changes during fade-in of Extender OSD (default: YES)
	deactivated	Function not active
Display Time	0-999 seconds	Duration of OSD fade-in (default: 10)
Horizontal Position	10 pixels	Horizontal OSD position (default: -2)
Vertical Position	10 pixels	Vertical OSD position (default: 2)



When setting the horizontal OSD position, a prefixed minus describes the orientation to the right edge of the monitor, e.g. -2 means $2 \times 10 = 20$ pixels to this edge. When setting a vertical position, a prefixed minus describes the orientation to the bottom edge of the monitor.

If the **Update Connections** function is deactivated, the Extender OSD only appears when switching via OSD.

You have the following options to access the menu:



OSD

➔ Select **Configuration > EXT Units** in the main menu.

The screenshot shows the OSD Configuration menu for EXT Units. The top bar displays 'admin@CON 010190841 (3112/4808)' and 'ihse ESC'. The main menu is titled 'Configuration' and includes function keys: F1:ID, F2:Name, F3:Next, F4:Previous, F5:Refresh, F6:Find, F9:Compare.

The 'EXT Units' list shows several entries, with '010190841 EXT 010190841' selected. The 'EXT Data' section displays the following settings:

- ID : 010190841
- Name : EXT 010190841
- CPU/CON assigned : 03004 CON_010190841
- Fixed : Port 1/2 : 1 / 0 Universal :
- General OSD Data:
 - Horizontal mouse speed [1/x]: 4
 - Vertical mouse speed [1/x]: 5
 - Double click time [ms]: 200
 - Keyboard layout : German DE_129
 - Video mode : 1920 * 1080
- Extender OSD Data:
 - Enable CPU selection :
 - Enable connection info :
 - Update connection info :
 - Display time [sec]: 10
 - Horizontal position : -2
 - Vertical position : 3

The 'EXT Type' section shows a table of input and output signals:

Input Signals	C#1	C#2	Output Signals	C#1	C#2
DVI/VGA-CPU (video ..)	<input type="checkbox"/>	<input type="checkbox"/>	DVI/VGA-CON (video ..)	<input checked="" type="checkbox"/>	<input type="checkbox"/>
HID-CON (keyb., mouse..)	<input checked="" type="checkbox"/>	<input type="checkbox"/>	HID-CPU (keyb., mouse..)	<input type="checkbox"/>	<input type="checkbox"/>
Audio (analog, digital)	<input type="checkbox"/>	<input type="checkbox"/>	Audio (analog, digital)	<input type="checkbox"/>	<input type="checkbox"/>
RS232 (serial ..)	<input type="checkbox"/>	<input type="checkbox"/>	RS232 (serial ..)	<input type="checkbox"/>	<input type="checkbox"/>
USB-CON (embedded)	<input type="checkbox"/>	<input type="checkbox"/>	USB-CPU (embedded)	<input type="checkbox"/>	<input type="checkbox"/>
USB-CON (standalone)	<input type="checkbox"/>	<input type="checkbox"/>	USB-CPU (standalone)	<input type="checkbox"/>	<input type="checkbox"/>
Universal-CON	<input type="checkbox"/>	<input type="checkbox"/>	Universal-CPU	<input type="checkbox"/>	<input type="checkbox"/>
Cascade-CON	<input type="checkbox"/>	<input type="checkbox"/>	Cascade-CPU	<input type="checkbox"/>	<input type="checkbox"/>

Buttons on the right include 'New', 'Edit', 'Delete', 'Cancel', and 'Okay'. The bottom status bar shows 'SWITCH 01:1' and 'Draco tera'.

Menu Configuration – EXT Units

In order to change the Extender OSD settings, proceed as follows:

1. Select the console extender in the **EXT Units** list whose Extender OSD settings has to be adjusted.
2. When confirming the selection by pressing <Enter>, the respective console extender will be enabled for editing.

Java-Tool

➔ Select **Extender & Devices > EXT Units** in the task area.

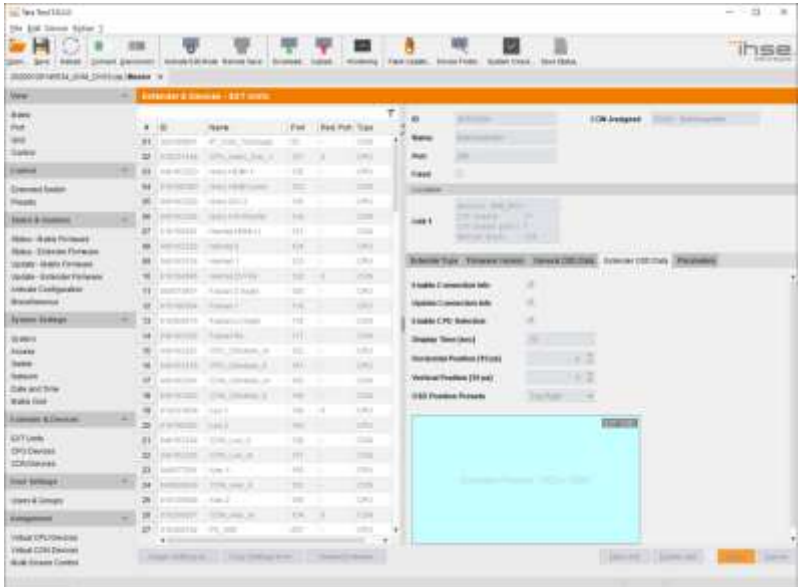

Menu **Extender & Devices - EXT Units**

In order to change the Extender OSD settings, proceed as follows:

1. Select the console extender in the **EXT Units** list for which the Extender OSD settings are to be adjusted.
2. Open the **Extender OSD Data** tab.
3. Adjust the desired settings and confirm your changes by pressing the **Apply** button.

5.13.4 Favorite List Consoles

Individual favorite lists of CPUs to be switched frequently can be created for all consoles in this menu. A favorite list can contain up to 16 different CPUs.

The switching of the favorites is done via 'Hot Key' using the keyboard (see Chapter 6.1.1, Page 204).

You have the following options to access the menu:



OSD

➔ Select **Assignments > CON Favorites** in the main menu.

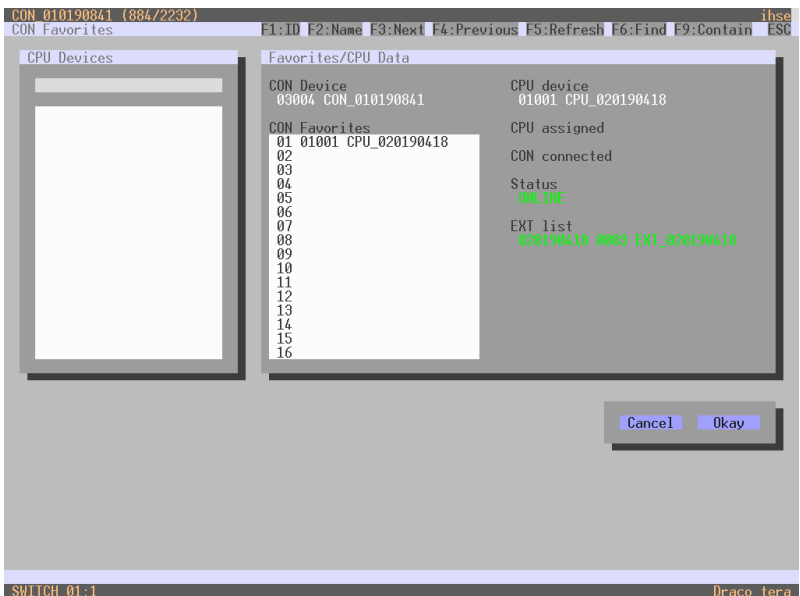

Menu Assignments – CON Favorites

To create a favorite list for your own console, proceed as follows:

1. Select a CPU to be moved to the favorite list on the **CPU Devices** list. Press <a> to move a CPU Device to the favorite list. Press <r> to remove a CPU from the favorite list.
2. The order of the CPU devices within the favorite list can be changed by pressing <+> and <->.
3. Press the **Save** button to save the settings.

Java Tool

- ➔ Select **Extender & Devices > CON Devices** in the working area and select the console for the favorite list. Open the **Favorites** tab.

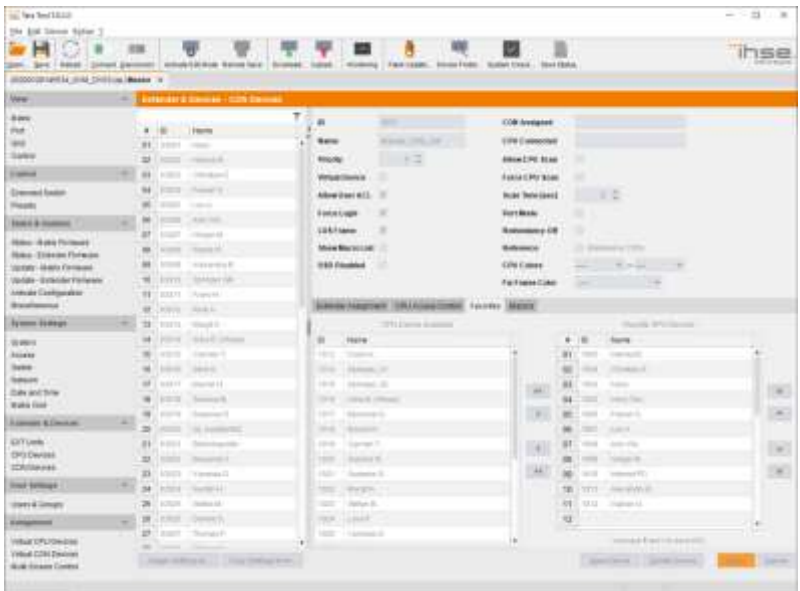

Menu *Extender & Devices - CON Devices*

To create a favorite list for any console, proceed as follows:

1. Select the CPUs in the **CPU available** list that should be added to the favorite list (**CPU assigned**). At the same time, multiple CPU Devices can be marked by pressing and holding <Ctrl>.
2. Press the > button to move the marked CPU Devices to the favorite list. If you press the >> button, the first eight CPU Devices from the list will be moved to the favorite list (**CPU assigned**).

3. The order of marked CPU Devices within the favorite list can be changed by pressing <+> and <->.
4. To remove marked CPU Devices from the favorite list, press the < button. If you press the << button, all CPU Devices will be removed from the favorite list.

5.13.5 Console Macros

In this menu macro commands for switching, disconnection or user administration can be created. The macro commands are created for each console separately.

A macro can execute up to 16 switching commands successively.

The execution of the macros is done via 'Hot Key' and the function keys <F1>-<F16> (see Chapter 6.1.3, Page 206).

You can select the following settings:

Field	Selection	Description
Function (01-16)	Connect (P1=CON, P2=CPU)	Set bidirectional connection from console P1 to CPU P2
	Connect Video (P1=CON, P2=CPU)	Set video connection from console P1 to CPU P2
	Disconnect (P1=CON)	Disconnect console P1
	Logout User	Logout current user
	Set Real CPU (P1=VCPU, P2=RCPU)	Assign a virtual CPU to a real CPU
	Set Virtual CON (P1=RCON, P2=VCON)	Assign a real console to a virtual console
	Push (P1=CON)	The KVM connection is forwarded to console P1 and is changed to a video only connection.

Field	Selection	Description
	Push Video (P1=CON)	The video signal of the current connection (KVM or video only) is forwarded to console P1. The connection remains unchanged (KVM or video only).
	Get (P1=CON)	The console gets a KVM connection to the CPU that is currently connected to console P1. The connection of console P1 is changed into a video only connection.
	Get Video (P1=CON)	The console gets a video only connection to the CPU that is currently connected to console P1. The connection of console P1 remains unchanged (KVM or video only).
	Login User	Login a certain user P1 at console P2
P1	CON or CPU Device	Name of CON or CPU Device
P2	CPU or CPU Device	Name of CON or CPU Device



The macros can also be used to switch to CPU groups.

You have the following options to access the menu:



OSD

- ➔ Select via **Configuration > CON Macros** in the main menu the console for which a console macro is to be created.

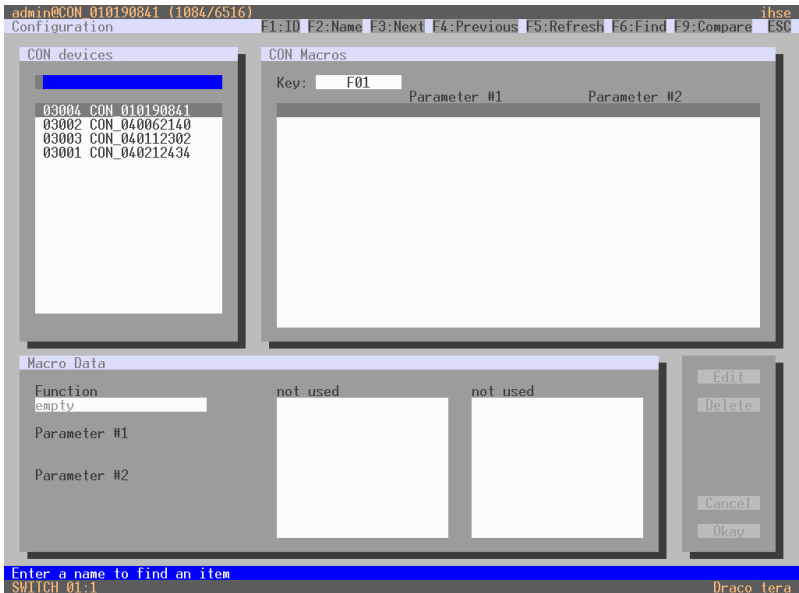

Menu **Configuration – CON Macros**

In order to create a macro for the selected console, proceed as follows:

1. Select in the **Key** field the function key (F1-F32) for which a macro should be created.
2. Select the respective place on the list (1-16) for the key that should be set with a macro key.
3. Select for the highlighted position on the list a macro command in the **Macro Data** field.
4. Set the necessary parameters **P1** and **P2** (e.g. CON Devices or CPU Devices) for the selected macro command.
5. Confirm your inputs by pressing <Enter> and repeat the process for further macro commands, if necessary.

Java-Tool

- ➔ Select **Extender & Devices > CON Devices** in the working area and select the console for which a macro has to be created. Open the **Macros** tab.

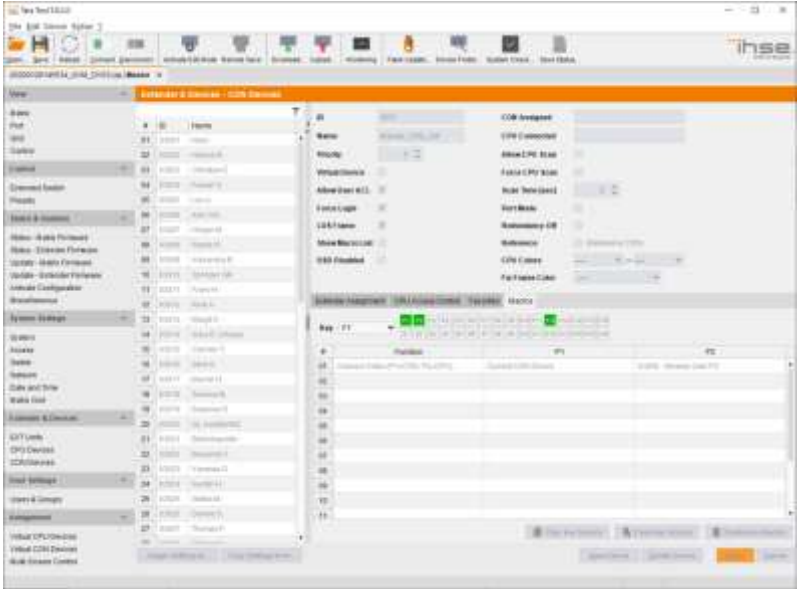

Menu *Extender & Devices - CON Devices*

In order to create a macro for the selected console, proceed as follows:

1. Select in the **Key** field the function key for which a macro has to be created.
2. Select in the **Function** column the commands that should be part of the macro. The selection list will be opened by a double click on the empty fields.
3. Select the respective parameters for the macro functions (e.g. corresponding consoles and CPUs) in the **P1** and **P2** columns.
4. Confirm your inputs by pressing the **Apply** button.

For an efficient macro configuration the following context functions are available:

- When clicking on the **Macros** tab, macros can be assigned to other consoles by using the **Assign Macros to ...** function and can be copied from other consoles by using the **Copy Macros from ...** function.
- When clicking on the macro list, macros of the selected key can be copied into the cache by using the **Copy Key Macros** function. You can paste the macros from the cache into a key by using the **Paste Key Macros** function and you can reset all macros of the selected key by using the **Reset Key Macros** function.

5.13.6 Shared Operation

This menu enables shared operation of a CPU Device by two or more CON Devices. A CPU Device can be controlled by only one CON Device at a time but can be taken over successively by other CON Devices. Control of a CPU Unit by a CON Unit is relinquished after the expiration of an inactivity timer associated with the controlling CON Device. The mouse or keyboard may also be used to take control.



In order to allow a smooth and accurate function of the shared operation, you should use identical mice and keyboards. They should be connected to the same USB-HID ports of each CON Unit.

The alternative is using the USB-HID Ghosting (see Chapter 6.14, Page 233).

When taking over control within 10 s, any assigned USB 2.0 / 3.0 extenders, if available, will not be switched due to security and stability aspects.

The shared operation will be deactivated between CON Devices with a different priority as well as the Release Time.

You have the following options to configure shared operation:



OSD

→ Select **Configuration > Switch** in the main menu.

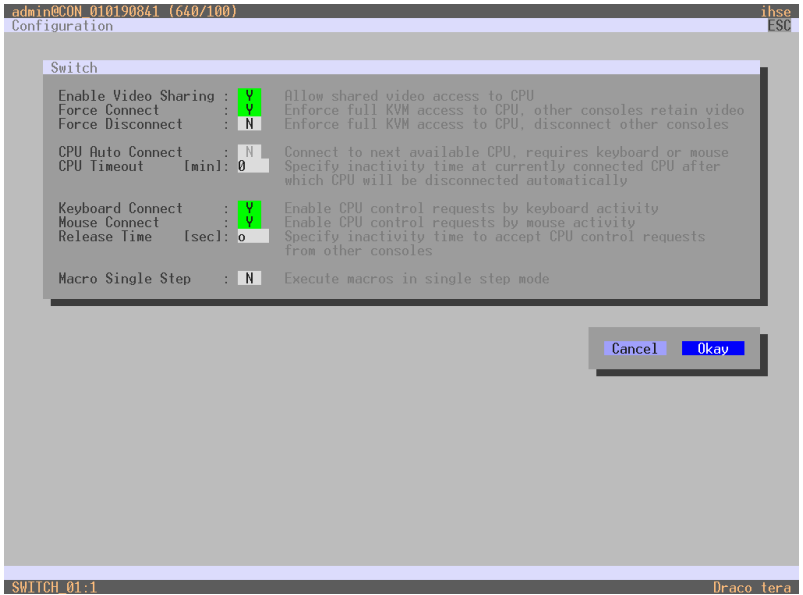

Menu Configuration – Switch

In order to configure shared operation, proceed as follows:

1. Activate the **Enable Video Sharing** function.
2. Activate the **Force Connect** function.
3. Activate the **Keyboard Connect** function, if taking over control by a keyboard event should be possible.
4. Activate the **Mouse Connect** function, if taking over control by a keyboard movement should be possible.
5. Define a **Release Time** of inactivity (0 - 999 sec.) after which control can be taken over.

Java-Tool

➔ Select **System Settings > Switch** in the task area.

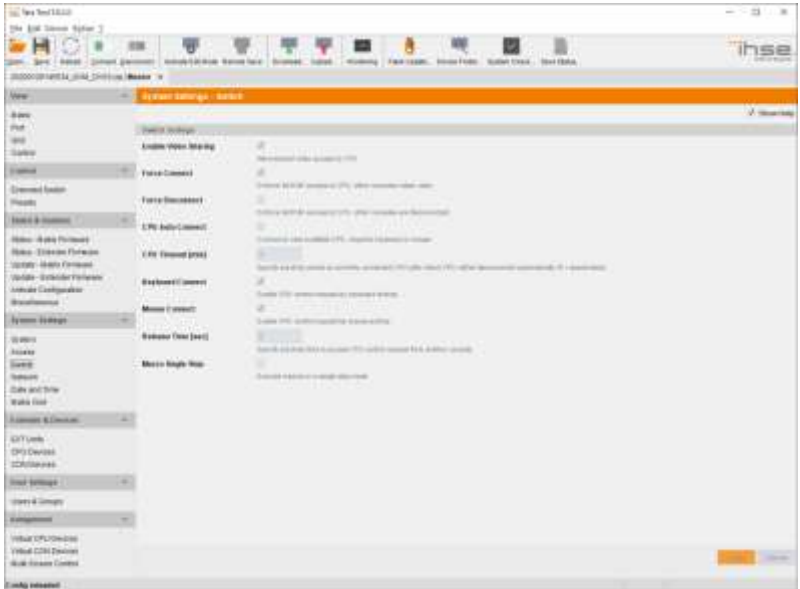

Menu **System Settings - Switch**

In order to configure shared operation, proceed as follows:

1. Activate the **Enable Video Sharing** function.
2. Activate the **Force Connect** function.
3. Activate the **Keyboard Connect** function, if taking over control by a keyboard event is to be permitted.
4. Activate the **Mouse Connect** function, if taking over control by a keyboard movement should be possible.
5. Define a **Release Time** of inactivity (0 - 999 sec.) after which control can be taken over.

5.13.7 Multi-Screen Control

This menu configures the USB-HID switching operation, allowing a CON Device with several monitors to control several connected sources (computers, CPUs). Smooth switching can be performed for up to eight connected sources by dragging the mouse pointer beyond the respective monitor to an adjacent one.

Monitors can be arranged side-by-side, in a grid layout or completely free.



When using sources (computers, CPUs) in multi-head operation (e.g. dual-head), the configuration must be executed via Java Tool to carry out the extended configuration options (from firmware V03.08).

A Multi-Head configuration for Apple Mac sources is not supported due to limitations of the macOS.

When using CON Units with the possibility to connect a local source (computer, CPU) in a Multi-Screen Control environment, the local switching will be disabled.



In order to enable Multi-Screen Control, all Extender Units assigned to the related CON Device, must be physically connected to the same block of 8 ports on the I/O board of the matrix.

When configuring Multi-Screen Control via OSD, the number of supported monitors is limited to four. This limitation also applies to the use of older hardware.



CON Units that have been already configured for Multi-Screen Control can be connected together to other blocks of 8 ports. In this case any further configuration is not necessary, their functionality will remain as set previously.

You have the following options to access the menu:



OSD (simple configuration for Single-Head applications)

➔ Select **Assignments > Multi-Screen Control** in the main menu.

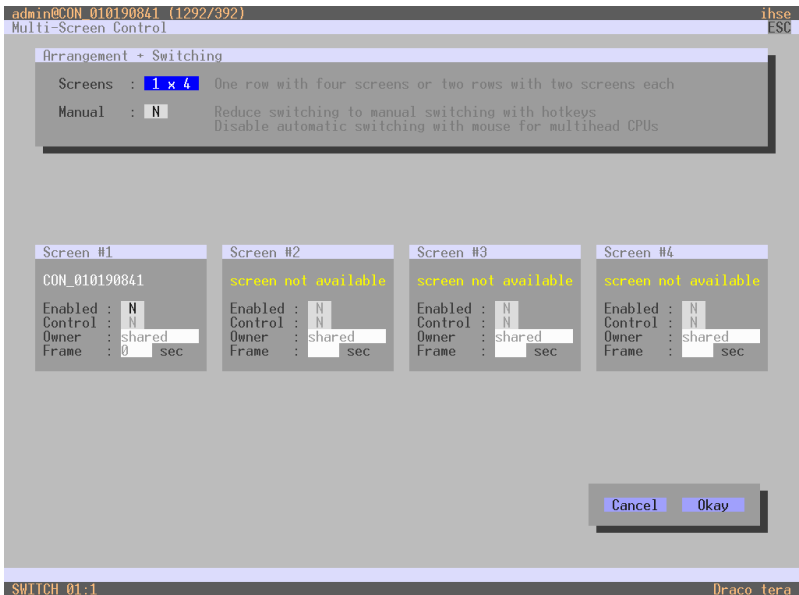

Menu Assignments – Multi-Screen Control

In order to configure the Multi-Screen Control, proceed as follows:

1. In the **Arrangement** field, select the layout for the CON Device you want to configure (**1 x 4** or **2 x 2**).
The fields for the configuration of the individual displays will be arranged accordingly.
2. Activate **Manual** option, if USB-HID switching is to be restricted to keyboard commands (see Chapter 6.7, Page 221).
Manual switching allows the use of multi-head consoles.
3. Ensure that the **Enabled** option is set to **Y** on all displays in order to activate the respective display for Multi-Screen Control.
4. Select one or more control displays within the CON Device by setting the **Control** function to **Y** in the display field.
Control displays are referred to the extender units within the Multi-Screen Control that are connected to keyboard and mouse.

- When using the **Owner** function, you can determine which control display is permitted for USB-HID switching to the different displays. Select that display from the list.
In order to make a display accessible to all neighboring control displays, set the **Owner** function to **shared**.
- Use the **Frame** function to configure a red frame that shows the current display with mouse control after the expiration of a selectable timer.
The frame to fade in can be individually activated by using a timer >0 seconds.

Java Tool (extended configuration for Multi-Head applications)

➔ Select **Assignment > Multi-Screen Control** in the task area.

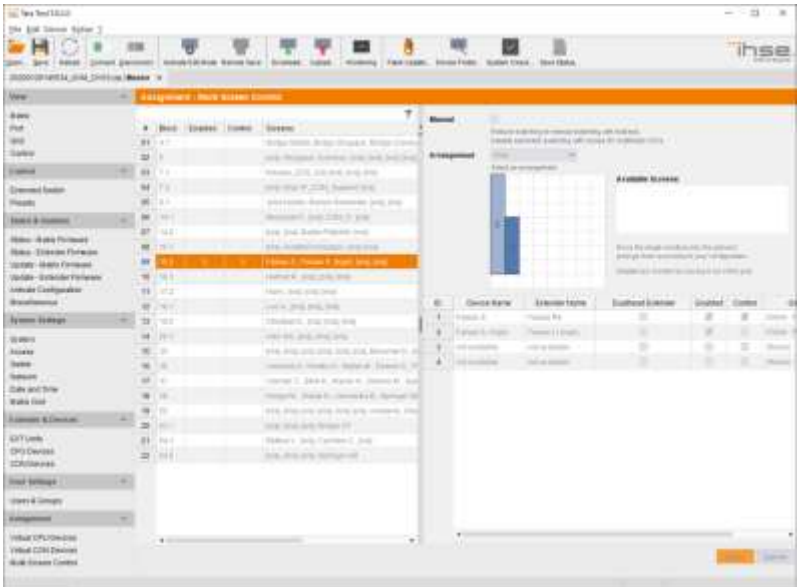

Menu **Assignment – Multi-Screen Control**

In order to configure the Multi-Screen Control, proceed as follows:

- Select the block of 4 or 8 ports in the list of the working area that should be configured for Multi-Screen Control.
Only blocks of 4 or 8 ports that contain at least one CON Unit are shown.

2. Activate **Manual** option, if the USB-HID switching is to be restricted to keyboard commands (see Chapter 6.7, Page 221).
Manual switching allows the use of multi-head consoles.
3. In the **Arrangement** field, select the layout for the CON Devices you want to configure. Select as follows:
 - **Horizontal**: horizontal arrangement
 - **Block**: block arrangement
 - **Free**: free arrangement (The free arrangement allows a flexible positioning of the displays for diverse applications.)

The fields for the configuration of the individual displays will be arranged accordingly.

4. Select one or more control displays within the CON Device by setting the **Control** function to **Y** in the respective display field.
Control displays are referred to the extender units within the Multi-Screen Control that are connected to keyboard and mouse.
5. When using the **Owner** function, you can determine which control display is permitted for USB-HID switching to the different displays. Select that display from the list.
In order to make a display accessible for all neighboring control displays, set the **Owner** function to **shared**.
6. Use the **Frame** function to configure a red frame that shows the current display with mouse control after the expiration of a selectable timer.
The frame to fade in can be individually activated by using a timer >0 seconds.
7. For the use of Multi-Head sources (computer, CPU), an additional configuration of the CPU Devices is mandatory. To do this, select **Extender & Devices > CPU Devices** in the working area. Select the CPU Device to be configured and open the tab **Monitor Arrangement**.
The configuration of CPU Devices, which are connected to Single-Head-Sources (computer, CPU) is not mandatory.
8. Enter the resolution of the total desktop area into the fields **Total Desktop Resolution**. For instance, if there are 4 graphic card outputs with a resolution of 1920x1080 each, you have to enter 7680 under **Width** and 1080 under **Height**.

9. Select the individual resolution of the graphic card output from the selection list in the field **Resolution 1** (e.g. 1920x1080). This is the graphic card output the CPU Device is connected to.
10. Enter the respective pixel coordinates of the CPU Device in the Multi-Screen Control arrangement into the fields **Offset X** and **Offset Y**. For instance, you have to enter 1920 for a shift of 1920 pixels to the right into the field Offset X.
11. If the CPU Device to be configured is a Dual-Head extender (482 series), activate the option **Dual-Head Extender**. Enter the resolution of the 2nd graphic card output and the offset information in the field **Resolution 2**.
12. For some operating systems it is necessary to activate the option **Multiplier**. This is mandatory, if you cannot reach all areas of the desktop with your mouse cursor.
13. After changing the configuration, a restart of the extender is mandatory. For this purpose, a corresponding popup window will occur after pressing the button **Apply**.

By executing steps 7-11 the CPU Device is configured for the Multi-Head operation and can be used now.

5.13.8 Active Directory

The KVM matrix can be synchronized with the directory service Active Directory with regard to user authentication. This allows the user to login at the KVM matrix using login information from the Active Directory service and to contact the Active Directory Server for each authentication that does in fact the proper authentication.

The connection between KVM matrix and the Active Directory server is established via OpenLDAP and periodically synchronized every 5 minutes.

The search of users to be synchronized and automatically added to the KVM matrix configuration can either be based on a **group** or an **organizational unit (OU)**. In both cases a user requires to be at least assigned to one group:

- In case of the group, all users belonging to a previously defined group on the active directory server are added to the KVM matrix and synchronized. In this alternative, the organizational structure of the organizational units (OUs) are added as matrix user group to the KVM matrix configuration. This means that the organizational unit (OU) that includes the user can be found as a matrix user group in the KVM matrix configuration after the synchronization. A user can be member of up to 8 groups.
- In case of the organizational unit (OU), all users belonging to groups that are located directly under this organizational unit are added and synchronized. The groups can also include subgroups. The structure of the groups is added to the KVM matrix configuration as user group. Each group will be represented in the KVM matrix as a user group after the synchronization. Groups that are located in sub organizational units will be ignored.

The integration of Active Directory is only available with the controller board 480-CTRL2.

You have the following options to configure the service:



OSD

To configure the synchronization to the Active Directory server, proceed as follows:

1. Select **Configuration > Network** in the main menu of the KVM matrix.
2. Activate at least the function **LDAP** and optionally **LDAP TLS/SSL**.
3. Enter the appropriate IP address and the port number in the field **LDAP Server** (default port number: 389).
4. Enter the LDAP Base DN into the appropriate field (e.g. dc=example, dc=com).

Note: Changes done in step 2 to 4 only come into effect after a restart of the KVM matrix.

5. Select **Configuration > User Data** in the main menu of the KVM matrix.

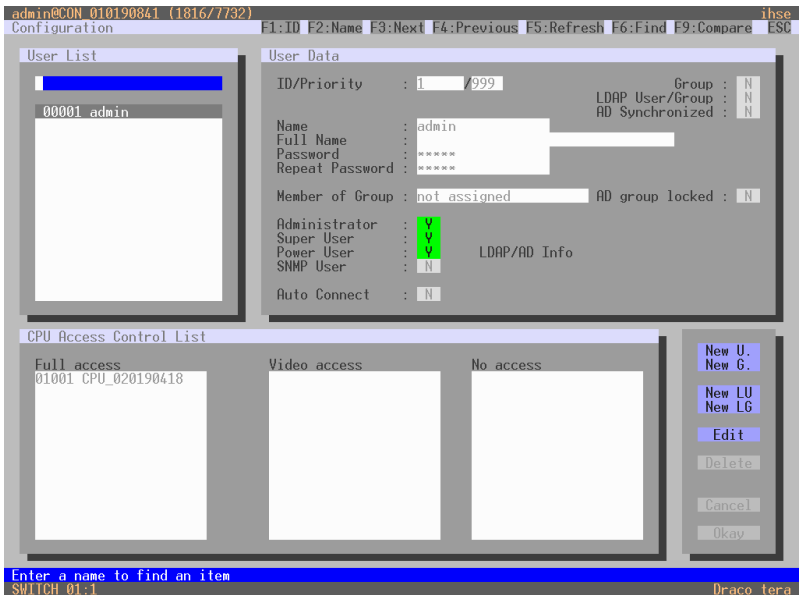

Menu **Configuration – User**

6. Press the button **New LU** to create a new LDAP user. This user functions as a bind user.
7. Enter a name into the field name **Name**.

8. Enter the Common Name (CN) of the bind user into the field **Login Name**.
9. Enter the password of the bind user from the Active Directory into the fields **Password** and **Repeat Password**.
10. Confirm the creation of the user with **Okay**.
11. Stay in the menu **Configuration > User Data**.
12. Press the button **New LG** to create a new LDAP group. The group determines which users of the Active Directory server should be synchronized.
13. Enter a name into the field **Name**.
14. Enter either the Common Name (CN) of a group or the Common Name (CN) of an organizational unit into the field **LDAP OU=/CN=** as shown below:
 - a. OU= name of the organizational unit
 - b. CN= name of the group
15. Confirm the creation of the group with **Okay**.

The Active Directory synchronization can be used now.



A matrix configuration should only include one LDAP user and one LDAP group at the same time. The LDAP user and the LDAP group can be created, changed or deleted during ongoing operation: No restart of the matrix is required.

Java Tool

To configure the synchronization to the Active Directory server, proceed as follows:

1. Select the tab LDAP under **System Settings > Network** in the working area.
2. Activate the function **LDAP** and optionally **Use TLS/SSL**.
3. Enter the respective IP address and port number into the field **LDAP Server** (default port number: 389).
4. Enter the LDAP **Base DN** into the respective field (e.g. dc=example, dc=com).
5. Select **User Settings > Users & Groups** in the task area.

Note: Changes done in the step 2 to 4 only come into effect after a restart of the KVM matrix.

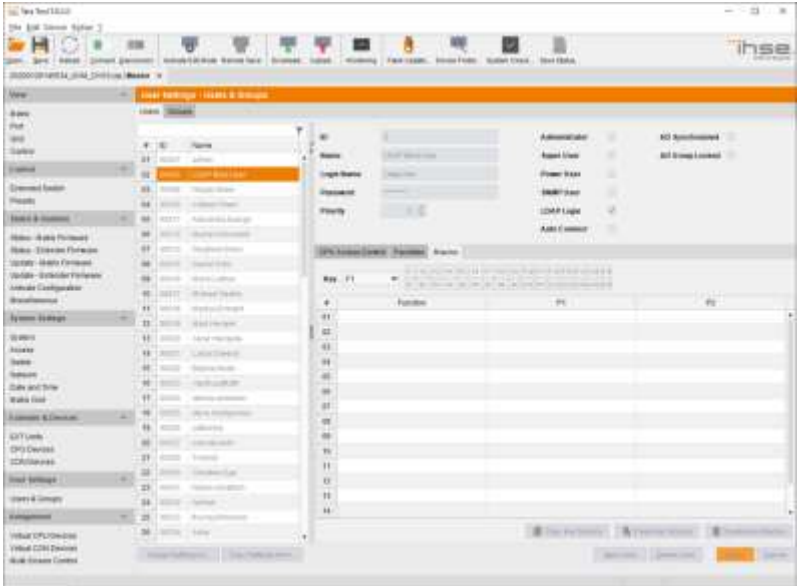

*Menu **User Settings - Users & Groups***

6. Create a new LDAP user (bind user) by pressing the button **New User**.
A popup window will appear.
7. Select **Create a LDAP User** in the popup window.
8. Enter a user name into the field **Name**.
9. Enter the Common Name (CN) of the bind user from the Active Directory into the field **Login Name**.
10. Enter the password of the bind user from the Active Directory into the field **Password**.
11. Confirm the creation of the user by pressing the button **Apply**.
12. Stay in the menu und open the tab **Groups**.
13. Press the button **New Group** to create a new LDAP group. A popup window will appear.
14. Select **Create a LDAP Group** in the popup window. The group determines which users of the Active Directory server should be synchronized.
15. Enter a name into the field **Name**.

16. Enter either the Common Name (CN) of a right group or the Common Name (CN) of an organizational unit into the field **LDAP OU=/CN=** as shown below:
 - a. OU= name of the organizational unit
 - b. CN= name of the right group
17. Confirm the creation of the user by pressing the button **Apply**.
The Active Directory synchronization can be used now.

5.14 Saving and Loading of Configurations

You have the option to set the following administration of configurations:

5.14.1 Active Configuration

You have the following option to access the menu:



- ➔ Select **Configuration > Save** in the main menu.

By selecting this menu item, the active configuration of the matrix is saved to the permanent matrix memory. By default, the last configuration that has been saved in this way will be restored after a restart of the matrix.



Changing or saving configurations blocks the matrix memory and leads to a freeze of all OSD menus for a few seconds. The switching connections are not affected by this freeze.

If you select **Auto Save** within the system settings an additional automatic saving of the configuration will be periodically performed (see Chapter 5.3.2, Page 80).

5.14.2 Saving of Configurations (internal)

In this menu the current matrix configuration is saved to predefined storage locations. However, it does not replace the buffering of configuration (see Chapter 5.14.1, Page 170).

You have the following options to access the menu:



In **Active**, the name and detailed information of the current configuration are shown. This configuration can be saved.

In **Default** and **File #1** to **File #8**, the name and detailed information of the respective saved configuration are shown. These storage locations can be overwritten.

The storage location to be overwritten by the current configuration must be selected explicitly.

The current configuration will be saved to this storage location and will be shown immediately in the menu. The previously saved configuration saved to this storage location is deleted.

OSD

You have the possibility to save the created configuration within eight storage locations in the matrix (**File #1 – File #8**). Additionally a configuration can also be saved as default configuration.

1. Select **Configuration > Save As...** in the main menu.
2. Select the required storage location (**File #1 – File #8**) or **Default**.

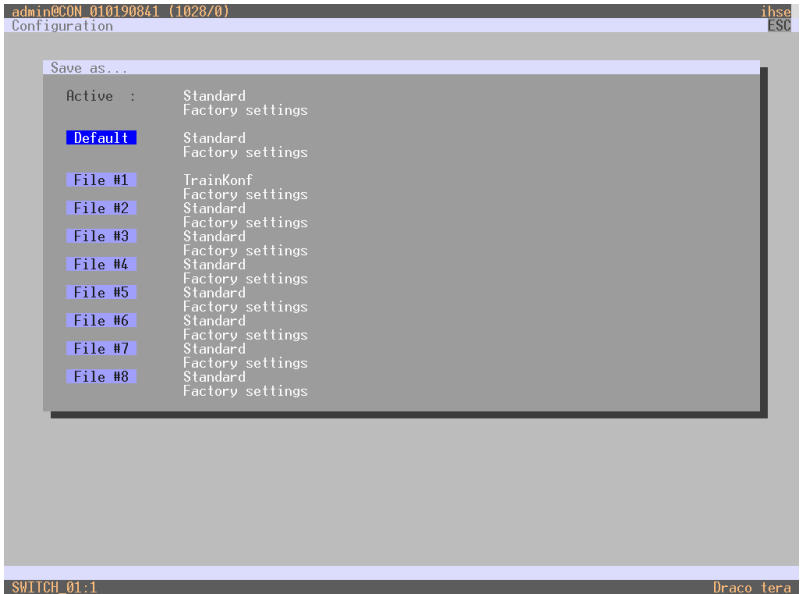

Menu Configuration – Save as

Java Tool

In order to save the configuration into the internal matrix memory, proceed as follows:

1. Select **File > Upload** in the menu bar.
2. Enter the IP address of the matrix, your user name and your password and confirm your inputs with the **Next** button.
3. Select the storage location in that the configuration has to be saved (**default** or **config01 – config08**) and confirm with the **OK** button.

*Menu **File – Upload***

5.14.3 Loading of Configurations (internal)

Previously saved configurations are loaded in this menu.

You have the following options to load configurations from files:



In **Active**, the currently loaded configuration is displayed.

In addition to the default configuration, up to eight further configurations can be loaded.

The selection of the configuration to be loaded can be made between eight personalizable configurations and the default settings.

The selected configuration is immediately loaded and displayed in the menu as **Active**. The previously active configuration is deleted.

OSD

1. Select **Configuration > Open** in the main menu.
2. Select the desired configuration.
3. Load the configuration by pressing <Enter>.

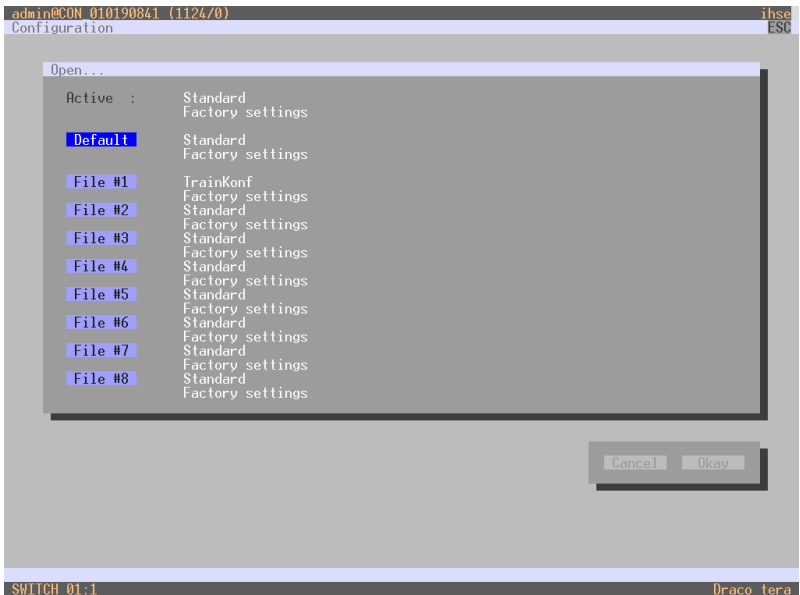

Menu **Configuration – Open...**

Java Tool

1. Select **Status & Updates > Activate Configuration** during online-mode in the task area
2. Select the desired configuration.
3. Load the configuration by pressing the **Activate** button.

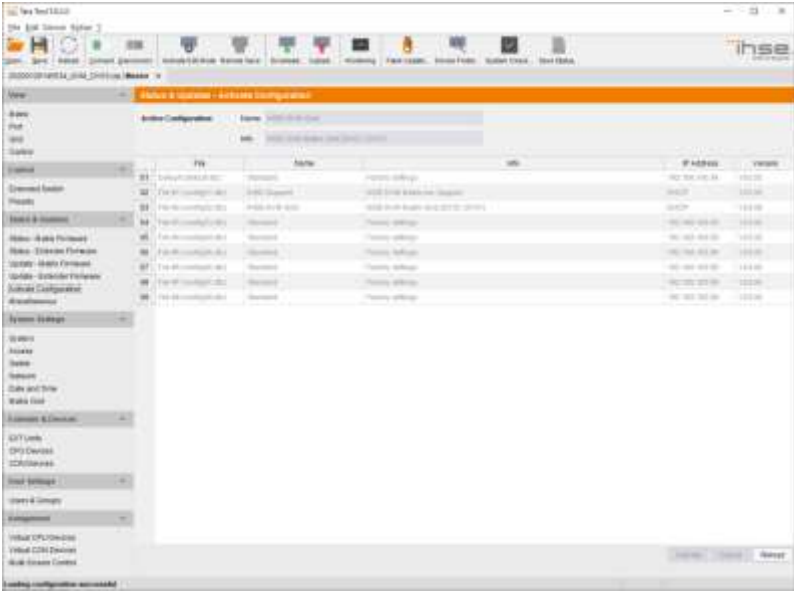

Menu **Status & Updates - Activate Configuration**

5.14.4 Saving of Configurations (external)

Configurations can be saved as a files that can be stored independent of the matrix.

You have the following option to access the menu:



1. Select **File > Save As** in the menu bar.
2. Enter a name for the configuration.
3. Select the directory of the configuration on your storage medium where it is to be saved.



Configurations are always saved in a file with the ending .dtc.

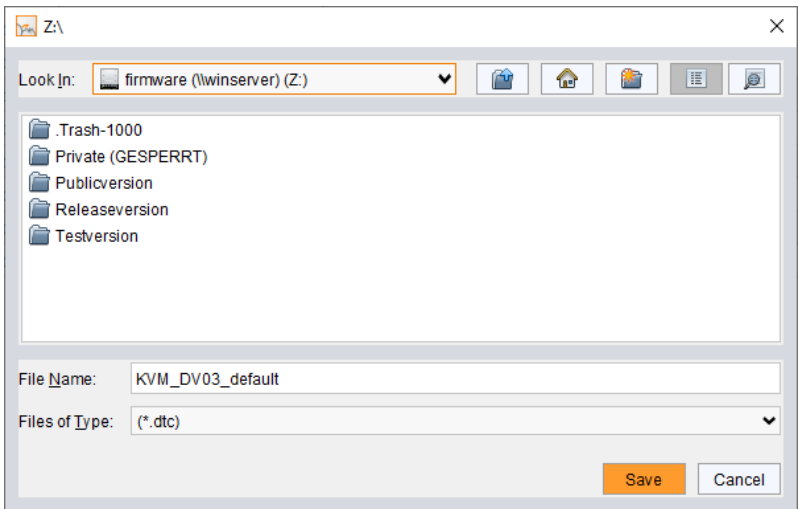

Menu File – Save As

5.14.5 Loading of Configurations (external)

Externally saved configurations are opened and activated in this menu.

You have the following option to load configurations from files:



1. Select **File > Open...** during offline-mode and select the storage location of the configuration file that has to be opened.
2. Open the configuration by pressing the **Open** button.
3. Select **File > Upload** in the menu bar to transfer the opened configuration to the matrix. Enter the necessary parameters.
4. Select **Device > Connect** in the menu bar to make a connection between the matrix and the Java Tool. Enter the necessary parameters.
5. Select **Status & Updates > Activate Configuration** and select the configuration to be activated.
6. Confirm the process with the **Activate** button.

The opened configuration is activated.

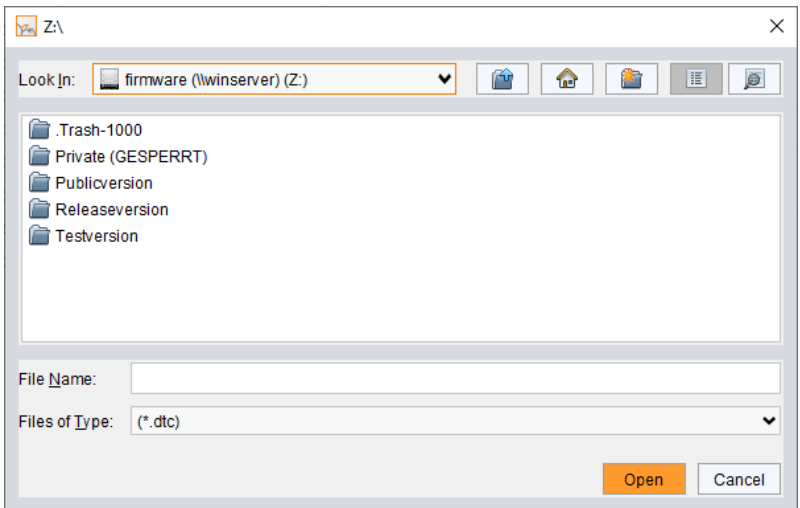

*Menu **File – Open...***

5.15 Export and Import Options

The Draco tera offers the ability to read out available configuration lists (extender, CPUs, consoles and users) for export and import again via Java Tool. You have the following option to handle configuration lists.

Exported configuration lists are always saved in .csv format that allows offline editing with common spreadsheet applications.

You have the following option to export or import configuration lists:



5.15.1 Export Options

Configuration lists are exported in this menu. In order to export, proceed as follows:

1. Select **File > Export** in the menu bar.
2. After opening the menu, select the list to export.
3. Select the storage location for the export file.
4. Confirm the export with the **Finish** button.

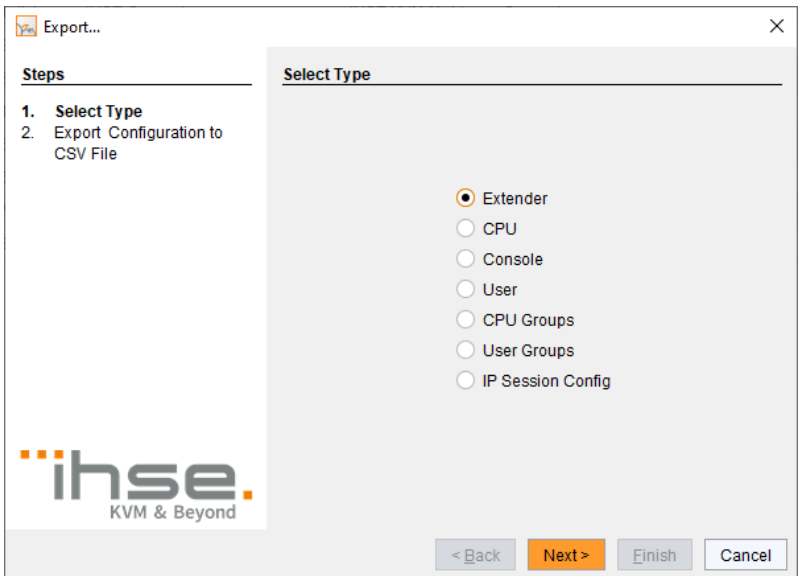

Menu File – Export

5.15.2 Import Options

Configuration lists are imported in this menu. In order to import, proceed as follows:

1. Select **File > Import** in the menu bar of an offline configuration.
2. After opening the menu, select the list to import (**Extender, CPU, Console or User**).
3. Select the directory of the list to import.
4. Confirm the import with the **Finish** button.



Importing configuration lists is only possible in offline configurations.

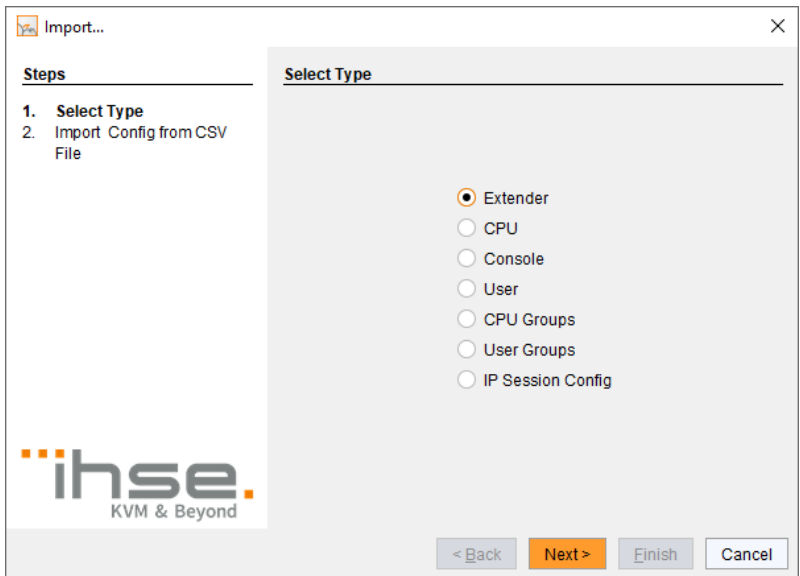

Menu **File – Import...**

5.16 Matrix Cascading

This simple method of cascading allows a switchable connection between two matrices via so called **Tie Lines**.

The Matrix Cascading does not require **Bundle 4**.

This kind of configuration may become necessary, if the number of ports in the entire system has to be increased or if certain important connections should be distributed to several matrices due to reasons of redundancy.

The Tie Lines are unidirectional and can only be used in one direction according to their configuration. For a bidirectional use of the cascading you have to configure opposite Tie Lines.

In order to connect Tie Lines to the matrices, you have to create intended **Cascade CON** and **Cascade CPU Devices** that have to be switched within the cascaded environment.

You have the following options to configure Matrix Cascading:



General Preparation

1. Define a **Master Matrix**. All further matrices will be configured as **Sub Matrices** in the configuration process.
2. Ensure that the Tie Lines will only connected after finishing the configuration.

OSD

- ➔ Select **Configuration > EXT Units** in the main menu of the master matrix.

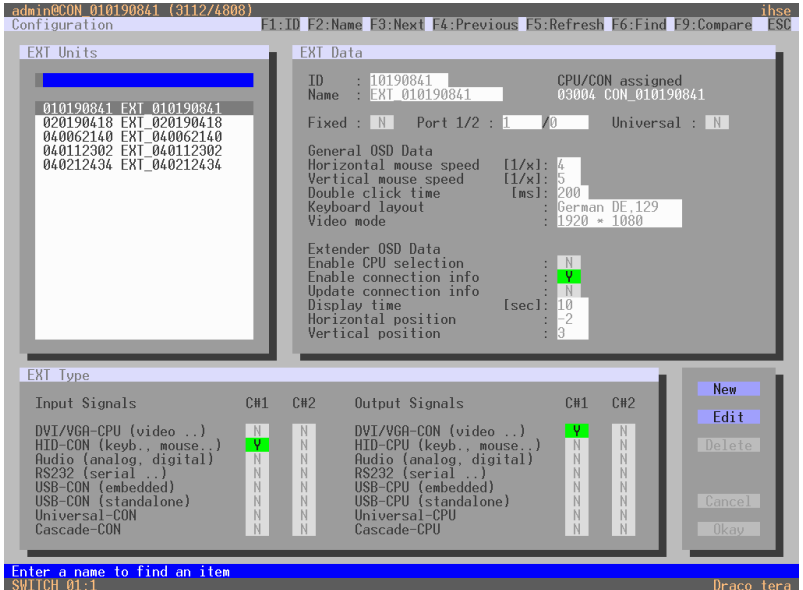

Menu Configuration - EXT Units

1. Press the **New** button.
A new Extender Unit will be created that is needed for the connection of Tie Lines.
2. Enter an appropriate extender name into the **Name** field.
3. Enter a port number into the **Port** field according to the required connection of the Tie Line.
4. If the Tie Line should be directed from the Sub to the Master, set the **Cascade-CON** option to **Y (C#1)** in the **Input Signals** column.
If the Tie Line should be directed from the Master to the Sub, set the **Cascade-CPU** option to **Y (C#1)** in the **Output Signals** column.
5. Save your settings by pressing the **Okay** button.
6. If you have created a Master/Sub CON Unit, select **Configuration > CON Devices** in the main menu of the master matrix and press the **New R** button.
A switchable CON Device will be created.

7. If you have created a Master/Sub CPU Unit, select **Configuration > CPU Devices** in the main menu of the master matrix and press the **New R** button.
A switchable CPU Device will be created.
8. Enter an appropriate Device name into the **Name** field.
9. Assign the previously configured Extender Unit to the just created Device by moving the Extender Unit from the **Ext available** field into the **Ext assigned** field and save your settings.
10. Repeat steps 1 to 9 for the Sub Matrix.
11. Select **Configuration > System** in the main menu of the Sub Matrix and set the **Sub Matrix** option to **Y**.
The OSD of the Sub Matrix will immediately freeze and will be only accessible by using the keyboard command <'Hot Key'>, <s>, <o>.
12. Restart all I/O boards on which any **Cascade CON** or **CPU** Units have been configured or alternatively restart the matrix.
13. Connect the Tie Lines to the matrices. Ensure that each **Cascade CON** on one matrix is connected to **Cascade CPU** on the other matrix in order to achieve switchability between two matrices.

The Matrix Cascading is now configured and can be used. Additional Tie Lines are configured accordingly. The use of cascading is described in Chapter 6.1.4, Page 207.

Java Tool

1. Connect to the Master Matrix and activate the **Edit Mode**.
2. Select the menu **Extender & Devices > EXT Units** in the task area and press the **New Unit** button.

A popup window opens.

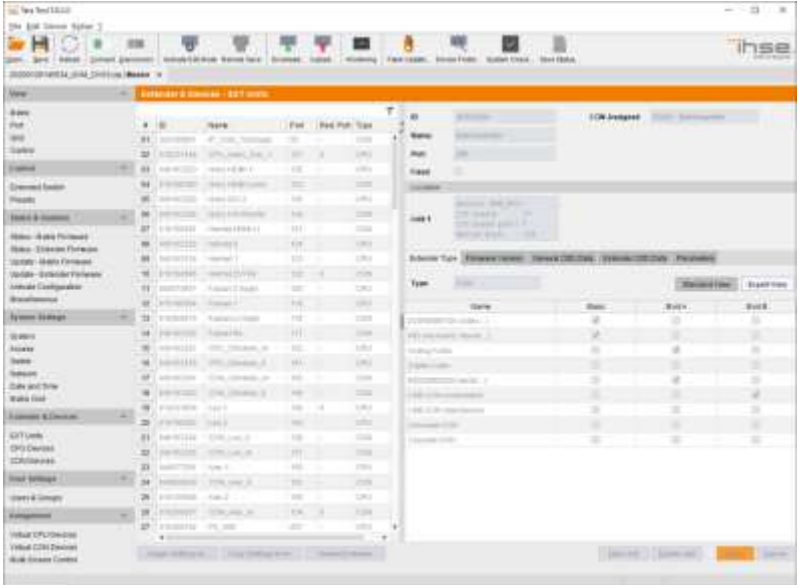

Menu **Extender & Devices - EXT Units**

3. If the Tie Line should be directed from the Sub to the Master, select **Cascading CON Unit** in the **Choose template** selection box.
If the Tie Line should be directed from the Sub to the Master, select **Cascading CPU Unit** in the **Choose template** selection box.
4. Enter an appropriate extender name into the **Name** field.
5. Enter a port number into the **Port** field according to the required connection of the Tie Line.
6. Confirm your settings by pressing the **Apply** button.
7. If you have created a Cascade CON Unit, select **Extender & Devices > CON Devices** in the task area of the master matrix and press the **New Device** button.

A switchable CON Device will be created.

8. If you have created a Cascade CPU Unit, select **Extender & Devices > CPU Devices** in the task area of the Master Matrix and press the **New Device** button.
A switchable CPU Device will be created.
9. Enter an appropriate extender name into the **Name** field.
10. Assign the previously configured Extender Unit to the just created Device by moving the Extender Unit from the **Extender available** field into the **Extender assigned** field and save your settings by pressing the **Apply** button.
11. Connect to the Sub Matrix and repeat steps 1 to 10.
12. Select **System Settings > System** in the task area of the Sub Matrix and activate the **Sub Matrix** option.
The OSD of the Sub Matrix will immediately freeze and will be only accessible by using the keyboard command <'Hot Key'>, <s>, <o>.
13. Restart all I/O boards on which any Master/Sub CON or CPU Units have been configured or alternatively restart the matrix.
14. Connect the Tie Lines to the matrices. Ensure that each **Cascade CON** on one matrix is connected to **Cascade CPU** on the other matrix in order to achieve switchability between two matrices.

The Matrix Cascading is now configured and can be used. Additional Tie Lines are configured accordingly. The use of cascading is described in Chapter 6.1.4, Page 207.

5.17 Matrix Grid

In this menu you can configure a Matrix Grid in order to connect two or more matrices. This kind of configuration may become necessary if the number of ports in the entire system has to be increased or if certain important connections should be distributed to several matrices due to reasons of redundancy.

The connections between two matrices have to be established by so called Grid Lines that are connected between particular I/O ports as connecting links. The Grid Lines can be used bidirectionally and can respectively handle a full access connection of a CON Device to a CPU Device.

The number of Grid Lines in the system specifies, if a CON Device can be switched to a CPU Device in Non-Blocking Access or in Blocking Access and has to be separately determined for each Grid environment.

In this case Non-Blocking Access means that a Grid Line for a cross-matrix switching operation of a CON Device to a CPU Device is available at any time.

Whereas Blocking Access means that for a certain switching operation no Grid Line may be available according to the switching status within the Grid. The result will be that no cross-matrix switching will be possible.

You have the following options to configure a Matrix Grid:



Administration of Settings

Within a Matrix Grid you have to differ between settings that have to be made locally for each matrix and settings that can be made globally so that they are valid for the whole Matrix Grid.

The settings in the following menus have to be made separately for each matrix or within the master matrix in order to affect all matrices in the Grid:

System, Access, Switch, Network, Date + Time, SNMP, Matrix Grid, Multi-Screen Control

The settings in the following menus have to be made globally and only once within the Matrix Grid:

EXT Units, CPU Devices, CON Devices, User, CON Macros, User Macros, CON Favorites, User Favorites, Virtual CPU Devices, Virtual CON Devices



If global settings are made in the respective menus, they will be immediately available on each matrix within the Matrix Grid.

General Preparation

The following requirements have to be fulfilled before starting the Matrix Grid configuration:

1. The Matrix Grid function (Bundle 4) must be activated on all matrices to be connected to the Grid by a license key (see Chapter 5.21, Page 202).
2. Firmware V03.10 must be installed on all matrices to be connected to the Grid, but with the same firmware on each matrix.
3. All matrices to be connected to the Grid must be within the same TCP/IP network (see Chapter 5.4.5, Page 99).
4. The port 5556 needed for network communication must not be blocked by a firewall.

OSD

In order to configure a Matrix Grid, proceed as follows. The following configuration steps have to be repeated for each matrix separately:

➔ Select **Configuration > System** in the main menu.

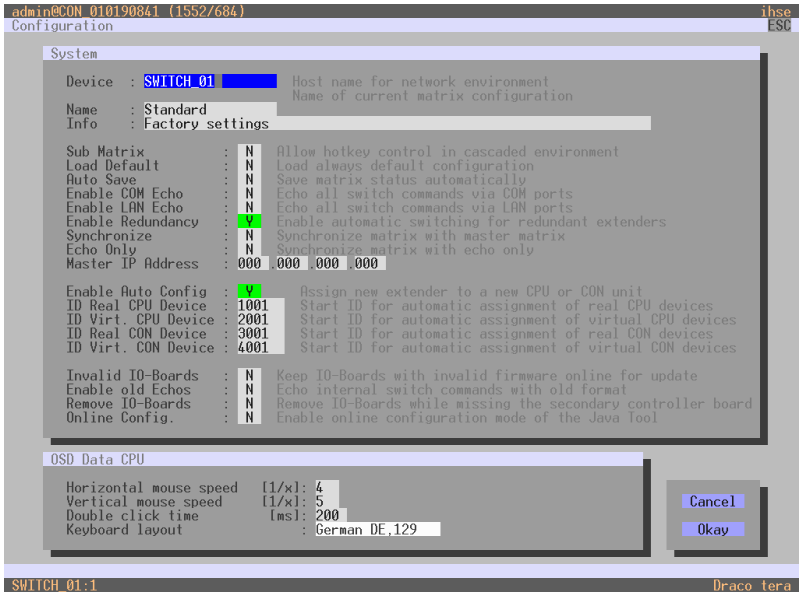

Menu **Configuration – System**

1. Enter a unique name for each matrix into the **Device** field. Each name only may exist once within the Matrix Grid.
2. Enter a unique Grid name into the **Name** field. The Grid name has to be same within all Grid matrices.
3. Select **Configuration > Matrix Grid** in the main menu.

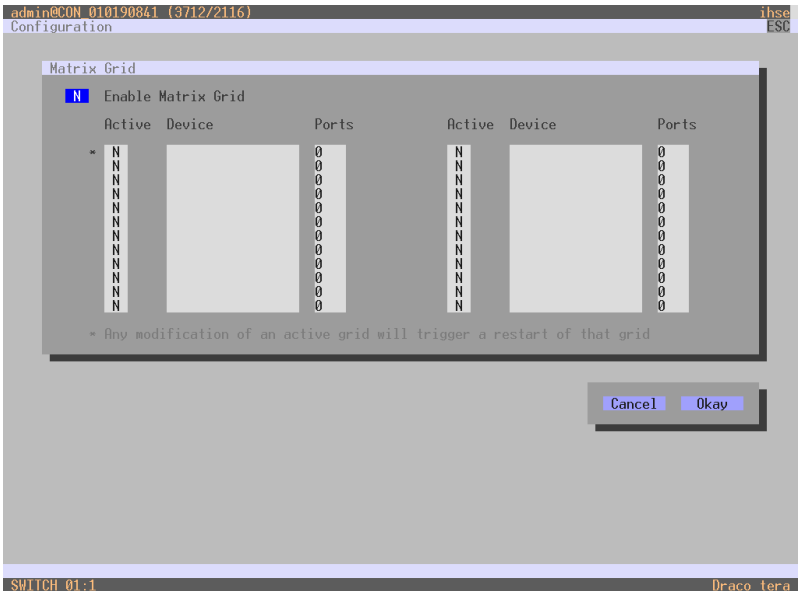

Menu **Configuration – Matrix Grid**

4. Activate the **Enable Matrix Grid** function.
5. Write all device names of the Grid matrices into the Matrix Grid list, starting in the left column. Based on the listings, a Grid master will be automatically determined for the Matrix-Grid. The more on the top a matrix is listed in the matrix Grid list, the more likely the matrix is considered in the automatic master selection, provided that certain criteria like system availability are fulfilled.
6. Activate the single matrices in the Matrix Grid list by enabling the **Y (YES)** function.
7. Enter the number of chassis ports for each matrix (**8, 16, 32, 48, 64, 80, 152, 160** or **288**).
8. Restart all matrices, beginning with the master matrix.

The Matrix Grid can be used now and offers the possibility for a cross-matrix switching of CON Devices to CPU Devices.

Java Tool

- ➔ In order to use the Matrix Grid execute the configuration wizard in the menu **System Settings > Matrix Grid**. It guides you through the configuration of Matrix-Grids.

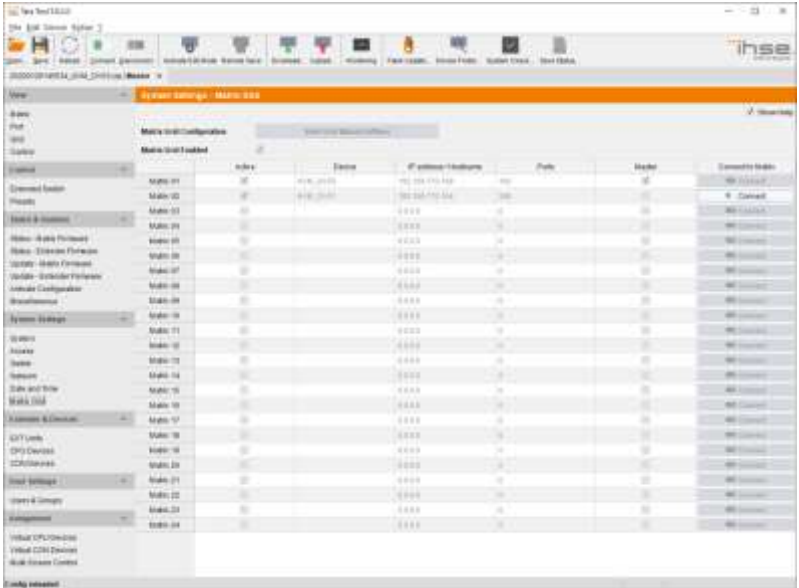

Menu System Settings - Matrix Grid

5.18 USB-HID Ghosting

This function allows specific keyboard and mice descriptors (device descriptions) to be permanently stored in the CPU unit. This eliminates the need to register and deregister the keyboard and mouse on an operating system each time there is a shared use of a source (computer, CPU) by two or more consoles within a KVM matrix.

Next to the use of Hot Keys commands (see Chapter 6.14, Page 233) the activation and management of the USB-HID Ghosting information can also be handled centrally via KVM matrix to reach all connected KVM extenders at the same time.

You have the following option to option to perform the central management of USB-HID Ghosting information:



General Preparation

To use the USB-HID Ghosting management via Java Tool, this requires that USB-HID Ghosting has been already activated at a CPU Unit via Hot Key command or the USB-HID Ghosting information is already available as a file with the extension .dhg.

Java Tool

Several general options are available. For these options select the menu **Extender & Devices > EXT Units** in the task area, select an EXT Unit (CPU) and open the tab **USB-HID Ghosting**:

- To read the USB-HID Ghosting information of an EXT Unit (CPU), select it and press the button **Read** in the symbol bar of the tab.
- To locally store existing USB-HID ghosting information of an EXT Unit (CPU), select it and press the button **Save As....**
- To delete existing USB-HID ghosting information of an EXT Unit (CPU), press the button **Reset**.

To transmit any manually activated USB-HID Ghosting information of a single EXT Unit (CPU) to other extenders, proceed as follows:

1. Connect to the KVM matrix via Java Tool and activate the **Edit Mode** mode in the symbol bar.

2. Select the menu **Extender & Devices > EXT Units** in the task area and select the EXT Unit (CPU) with active USB-HID Ghosting.

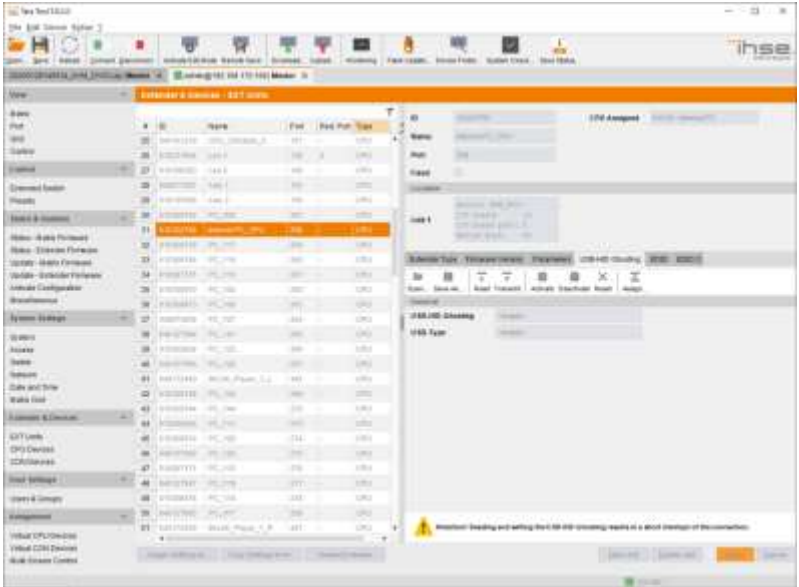

Menu **Extender & Devices - EXT Units**

3. Select the tab **USB-HID Ghosting**.
4. Press the button **Read**. The current USB-HID Ghosting information of the EXT Unit (CPU) is read out and shown. At the same time, the USB-HID connection will be disconnected for a few seconds.
5. Press the button **Assign....**
A popup window will appear.
6. Select the those EXT Units (CPU) in the field **Available to assign settings to** that are intended to receive the USB-HID Ghosting information.
7. Press the respective button to move the EXT Units (CPU) into the field **Assign settings to....**
8. Press the button **Next >**, confirm the occurring notification and finally press **Next >** again.
9. Press the button **Start** to activate the transmission and press the Button **Finish** as soon as the transmission is completed.

To load a USB-HID Ghosting template (.dmg file extension) for a further distribution proceed as follows:

1. Press the button **Open** in the tab **USB-HID Ghosting**.
2. Select the respective template with the file extension .dmg and press the button **Select**.
3. Select the EXT Unit (CPU) the USB-HID Ghosting template should be transmitted to and press the button **Transmit**.
4. If required, the USB-HID Ghosting information can be transmitted to any connected extender by pressing the button **Assign...**



During reading and writing USB-HID Ghosting information, there will be a short interrupt of the USB-HID and video signal.

5.19 Management of DDC Information (EDID)

By default, the KVM extenders transmit the factory preset DDC (EDID) to the sources (computer, CPU). This information is suitable in most cases.

For special requirements, DDC information can be retrieved and uploaded as a binary file to both the CPU Unit and the CON Unit.

Next to the use of Hot Keys commands (see Chapter 6.14, Page 233) the activation and management of the DDC information can also be handled centrally via KVM matrix to reach all connected KVM extenders at the same time.

You have the following option to manage DDC Information:



General Preparation

To use the DDC information management via Tera tool, this requires that DDC information has been already transmitted at a CPU Unit via Hot Key command or the DDC information is already available as a file with the extension .bin.

Java Tool

Several general options are available. For these options select the menu **Extender & Devices > EXT Units** in the task area, select an EXT Unit (CPU) and open the tab **EDID**:

- To read the DDC information of an EXT Unit (CPU), select it and press the button **Read** in the symbol bar of the tab.
- To locally store existing DDC information of an EXT Unit (CPU), select it and press the button **Save As....**
- To set existing DDC information of an EXT Unit (CPU) back to factory default, press the button **Reset**.

To copy any manually transmitted USB-HID Ghosting information of a single EXT Unit (CPU) to other extenders, proceed as follows:

1. Connect to the KVM matrix via Java Tool and activate the **Edit Mode** in the symbol bar.
2. Select the menu **Extender & Devices > EXT Units** in the task area and select the EXT Unit (CPU) with already transmitted EDID information.

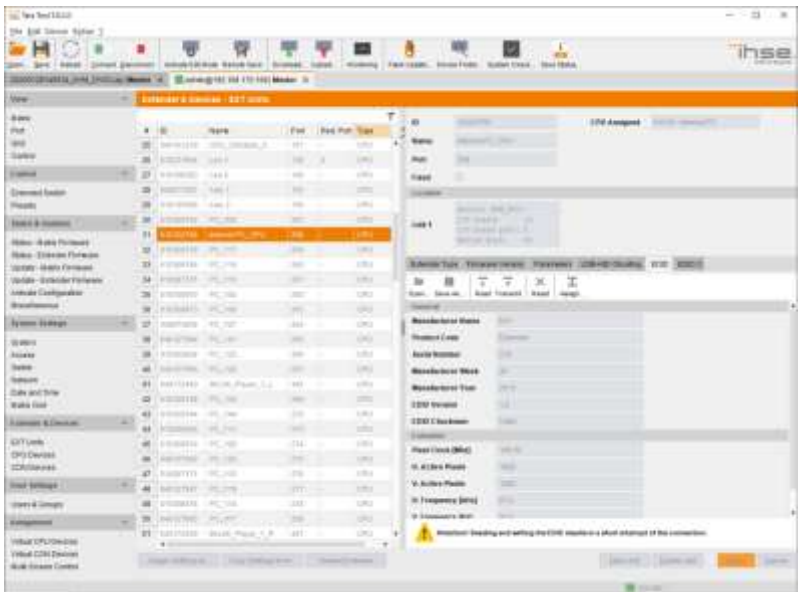

Menu **Extender & Devices - EXT Units**

3. Select the tab **EDID**.

4. Press the button **Read**.
The current DDC information of the EXT Unit (CPU) is read out and shown.
5. Press the button **Assign...**
A popup window will appear.
6. Select those EXT Units (CPU) in the field **Available to assign settings to** that are intended to receive the USB-DDC information.
7. Press the respective button to move the EXT Units (CPU) into the field **Assign settings to....**
8. Press the button **Next >**, confirm the occurring notification and finally press **Next >** again.
9. Press the button **Start** to activate the transmission and press the Button **Finish** as soon as the transmission is completed.

To load a DDC information template (.bin file extension) for a further distribution proceed as follows:

1. Press the button **Open** in the tab **EDID**.
2. Select the respective template with the file extension .bin and press the button **Select**.
3. Select the EXT Unit (CPU) the DDC template should be transmitted to and press the button **Transmit**.
4. If required, the DDC Ghosting information can be transmitted to any connected extender by pressing the button **Assign....**

5.20 Firmware Update

5.20.1 Matrix Update

The firmware of the matrix can be updated in this menu.

You have the following option to access the menu:



Java Tool



Only use computers to update the matrix that are not integrated into the KVM extender / matrix setup.

Ensure that the computer used for the update is not set into stand by mode or sleep mode during the update.

Ensure that your configuration has been saved externally before you start the update.

For reasons of network stability, an update via WLAN is not recommended.

Preparation

Take the following steps in order to be prepared for the matrix update:

1. Save the matrix configuration externally (see Chapter 5.14.4, Page 176).
2. Open **Extras > Options** in the menu bar and insert in the setting **Firmware Directory** the directory from which the update files should be standardly sourced.
3. Put all hot spare boards into the matrix.
4. Activate the Syslog function (see Chapter 3.9, Page 44) for the monitoring of the update, if unlocked via license key.



Ensure that all USB 2.0 extenders are only connected to the provided ports (fixed ports) before you start the matrix update. Non-compliance may affect the stability of the update.

Performing the Update

Take the following steps in order to be prepared for the matrix update:

1. Select **Status & Updates > Update - Matrix Firmware** in the task area. All updateable components of the matrix will be automatically selected and highlighted in green.

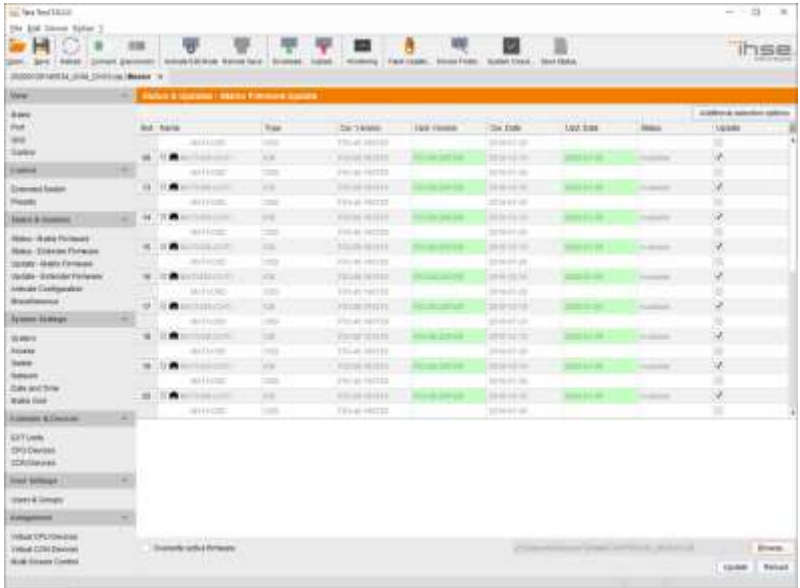

Menu **Status Status & Updates - Update - Matrix Firmware**

2. Start the update by pressing the **Update** button in the lower part of the working area.
3. Restart the Matrix after the update by pressing the **Restart matrix** button in the lower part of the working area.

Update of a 576 Port KVM Matrix

To update a 576 port KVM Matrix, proceed as follows based on the previous chapter **Performing the Update**:

1. Update the lower part of the KVM matrix by using the lower CPU board.
2. **Do not** execute a restart of the KVM matrix after the update.

3. Update the upper half of the KVM matrix by using the upper CPU board (master).
4. Reboot the KVM matrix after finishing both update steps.



For a safe initialisation of the matrix, a cold start (power cycle) is recommended.

5.20.2 Extender Update

The firmware of the extenders connected to the matrix can be updated in this menu.

You have the following option to access the menu:



Preparation

Take the following steps in order to be prepared for the extender update:

1. Save the matrix configuration externally (see Chapter 5.14.4, Page 176).
Open **Extras > Options** in the menu bar and insert the name of the directory from which the update files should be sourced in **Firmware Directory**.
2. Connect all hot spare extenders to the matrix.



For reasons of network stability, an update via WLAN is not recommended.

Performing the Update in Standard Mode (parallel Update)

1. Select **Status & Updates > Update - Extender Firmware** in the task area. The standard mode for the parallel update will be selected by default and the **Upload Firmware** tab will be opened.

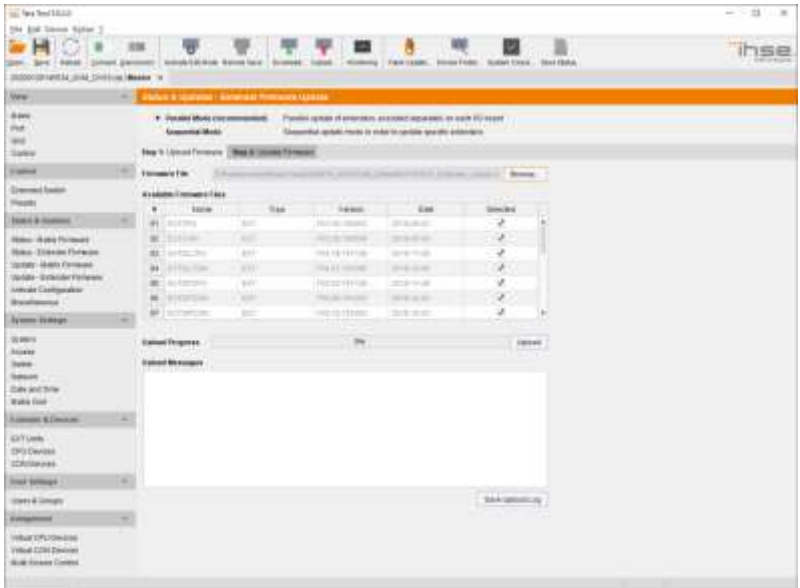

Menu **Status & Updates - Update - Extender Firmware**

2. Before the actual update process, all firmware files have to be uploaded to the respective I/O boards on that extenders will have to be updated. If a newer firmware is available, appropriate I/O boards will be automatically selected for the upload in the **Selected** column and highlighted in green.
3. Start the upload and distribution of the update files by pressing the **Upload** button.



By performing the upload process, no update files will be installed. the update process can be performed at a later time.

If there are not selected all I/O cards, the upload of the update files will be performed in sequence.

- After finishing the upload process successful completion will be confirmed by a popup message. If you want to directly start the actual update process, you will have to confirm this by pressing the **Yes** button. You will be immediately forwarded to the **Update Firmware** tab.



When updating an identical or an older firmware version than the version currently installed, the **Force Update** option in the lower part of the working area must be enabled.

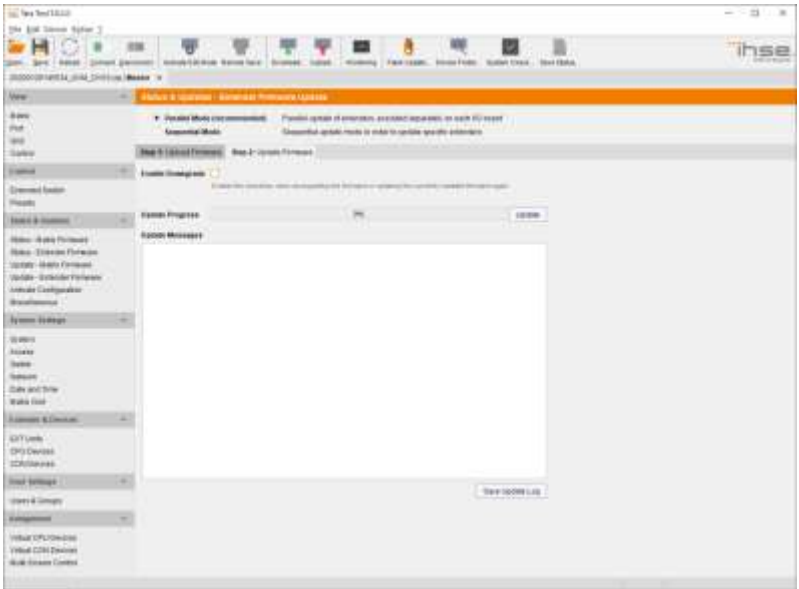

Menu **Status & Updates - Update - Extender Firmware**

- Start the actual update process by pressing the **Update** button.



Just before the update process, all affected I/O boards will be set into **Service Mode** and retrieved gradually after finishing the respective updates.

Performing the Update in Expert Mode (sequential Update)

Take the following steps in order to be prepared for the extender update:

1. Select **Status & Updates > Update - Extender Firmware** and select **Sequential Mode** in the upper part of the working area. All updateable extenders will be automatically selected and highlighted in green.

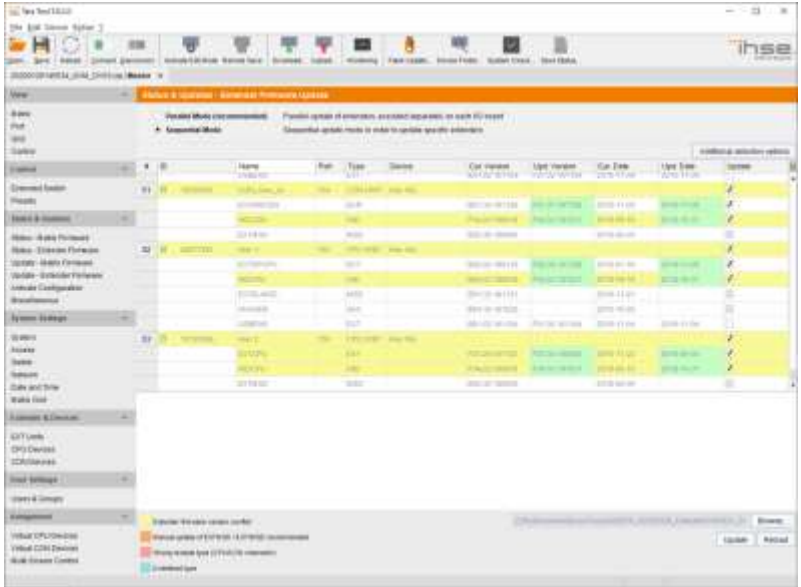

Menu Status & Updates - Update - Extender Firmware

2. Set the matrix into Service Mode upon request in the popup window or via **Device > Advanced Service > Activate Service Mode** in the menu bar.

During activation, all matrix functions are disabled on the I/O boards on which an update is currently performed. An OSD picture indicates the activation of the Service Mode and is displayed on all monitors that are connected to the matrix via a CON device. In addition, the Service Mode is indicated by a red tool icon in the lower part of the working area.

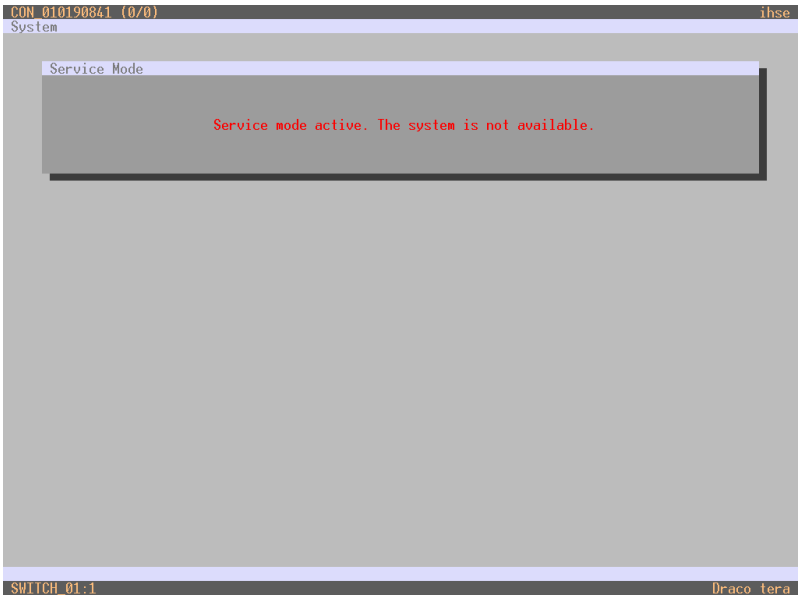

OSD View **Service Mode**

3. Start the update by pressing the **Update** button in the lower part of the working area.
4. Quit Service Mode after updating after responding to the confirmation request in the popup window or via **Device > Advanced Service > Deactivate Service Mode** in the task area.
5. Verify after the update in the Java Tool via **Administration > Update EXT Firmware** in the **Protocol** tab of the **Expert Mode**, if the updates for all extenders have been installed correctly.

5.21 License Management

In this menu the matrix can be upgraded with new function bundles by installation of license keys.



To obtain license keys to upgrade matrix functions, contact your distributor.

You have the following option to access the menu:



Java Tool

In order to activate a function bundle, proceed as follows:

1. Select **Status & Updates > Miscellaneous** in the task area.

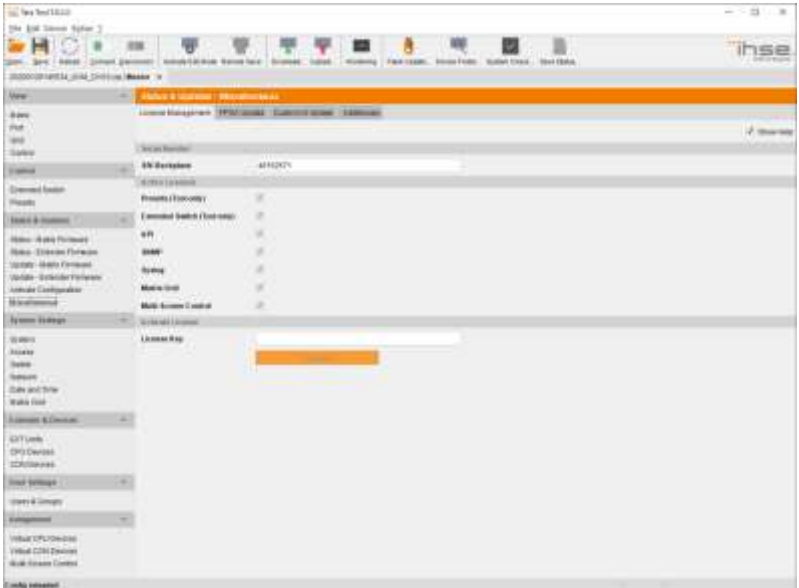

Menu **Status & Updates - Miscellaneous**

2. Enter your license key in the working area under **Activate License** in the **License Key** field.
3. In order to activate the license key press the **Activate** button. The new functions will be immediately enabled, a restart of the matrix will not be necessary.

6 Operation

The Draco tera can be operated in three different ways:

1. Direct Switching

- via a keyboard connected to a CON port and the favorites
- by a macro keyboard connected to a console port

2. OSD

- via keyboard/mouse directly connected to the CPU board of the matrix
- via keyboard/mouse connected to a CON Unit and the OSD

3. External Switching Commands:

- via an external computer via Java Tool (network connection required)
- via a media control (network or serial connection required)

6.1 Operation via 'Hot Keys'

6.1.1 Direct Switching

The direct switching by favorites on a keyboard is the fastest possibility for a user to switch at his console between different CPUs. This offers the option to switch video, keyboard and mouse or video only.

Direct Switching of Video, Keyboard and Mouse

1. Start Command Mode with the 'Hot Key'.
Shift and **Scroll** LEDs on the keyboard will flash, if Command Mode is activated.
2. Enter the index number of the new CPU from the list of favorites and confirm with <Enter>.

At the same time the Command Mode is closed and the console is connected to the new CPU which takes over complete control.

Example: Switching to favourite CPU 7 with video, keyboard and mouse
<left Shift>, <left Shift>, <7>, <Enter>



Fastest switching time can be achieved by using identical mice, keyboards and monitors. This contributes to a smooth and seamless direct switching of the matrix.

Switching in Private Mode

1. Start Command Mode with the 'Hot Key'.
Shift and **Scroll** LEDs on the keyboard will flash, if command mode is activated.
2. Enter the index number of the new CPU from the list of favorites and confirm with <left Shift>, <Enter> pressed at the same time.

At the same time the Command Mode is closed and the console is connected to the new CPU with complete control in **Private Mode**.

Example: Switching to favorite CPU 3 in **Private Mode**

<left Shift>, <left Shift>, <3>, <left Shift>, <Enter>

Direct Switching of Video

1. Start Command Mode with the 'Hot Key'.
Shift and **Scroll** LEDs on the keyboard will flash, if command mode is activated.
2. Enter the index number of the new CPU from the list of favorites and confirm with <Space>.
At the same time Command Mode is closed and the console is connected to the new CPU with video only.

Example: Switching to favourite CPU 1 with video only

<left Shift>, <left Shift>, <1>, <Space>

Switch to previous CPU

1. Start Command Mode with the 'Hot Key'.
Shift and **Scroll** LEDs on the keyboard will flash, if Command Mode is activated.
2. Press the key <p> of your keyboard.
At the same time Command Mode is closed and the console is connected to the previous CPU with complete control.



If you switch to a CPU that was previously connected with Video Access only, you will be connected to this CPU with full KVM access.



You can only switch to valid, unused CPUs using 'Hot Keys'. The options **Force Connect** and **Force Disconnect** as well as the restrictions of the User ACL and CON ACL are taken into account.

'Hot Keys' are only supported, if neither **Enable User Login** nor the **Enable User ACL** is selected and the user is logged in the OSD.

Disconnect current Connection

1. Start Command Mode with the 'Hot Key'.
Shift and **Scroll** LEDs on the keyboard will flash, if Command Mode is activated.
2. Press the key <Backspace> of your keyboard.
The Command Mode is closed and the console is disconnected from the previous connected CPU.

6.1.2 Scan Mode

Scan Mode enables fast switching between video signals from different CPUs registered as favorites without continuously using the 'Hot Key'. Switching between two video signals can even take place within one frame.

1. Start command mode with the 'Hot Key'. **Shift** and **Scroll** LEDs on the keyboard will flash, if command mode is activated.
2. Press the key <Left Shift> and hold it down. You can now enter the index numbers of the various CPUs from the list of favorites with the keyboard and immediately switch to the video signal of the respective CPU after entering the index number.
3. Leave Scan Mode by pressing <Left Shift> + <Esc>.



Optimal results can be achieved by the use of as identical resolutions as possible. This contributes to a smooth and seamless function of the scan mode.

6.1.3 Function Keys <F1>—<F16>

In Command Mode you can retrieve the macros 1–32 with the function keys <F1>—<F16> on the connected standard keyboard instead of the special macro keyboard.

Executing macros 17-21 is realized by the simultaneous use of the key <left Shift>.

The stored command sequence for the appropriate function key is executed and Command Mode is left immediately.

It is not necessary to use <Enter> to confirm selection of macros.

6.1.4 Addressing of Master and Sub Matrices

The Draco tera can be cascaded over two levels. You can either send the commands (including opening the OSD) to the master or the sub matrix.

When in command mode, you can select whether commands should be handled in the master or the sub matrix.

OSD Access

- OSD access to the master matrix:
<Left Shift>, <Left Shift>, <m> (optional), <o>
- OSD access to the sub matrix:
<Left Shift>, <Left Shift>, <s>, <o>

In order to do a cross-matrix switching, proceed as follows:

1. Open the OSD of the master matrix with the following keyboard sequence:
<'Hot Key'>, <o>
2. Select the CPU device configured as Tie Line in the CPU selection list and press <Enter> to switch onto.
3. Open the OSD of the sub matrix with the following keyboard command:
<'Hot Key'>, <s>, <o>
4. Select your target CPU in the CPU selection list of the sub matrix.



The selected master matrix / sub matrix mode is permanently activated until the other mode will be manually activated. This means that if you select <s>, all prospective commands will be sent to the sub matrix, but not if the Command Mode is left in the meantime.

6.2 KVM-Switching

You have the following option to perform switching operations with the Draco tera:



OSD

➔ Select **Switch** in the main menu.



By pressing <F8>, inactive CPU devices can be shown in order to expand the current view.

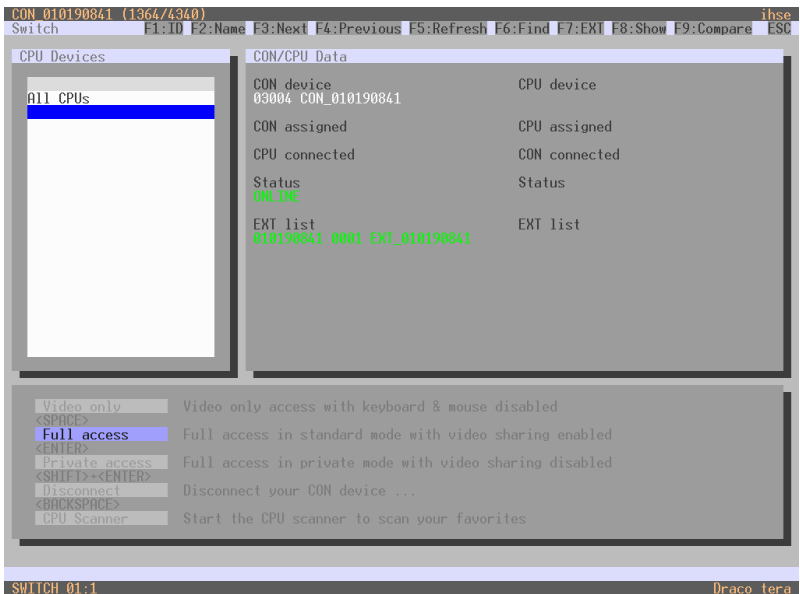

Menu **Switch**

To switch the console to any available CPU, proceed as follows:

1. Select in the **CPU Devices** list on the left hand side that one that should be connected to the CON Device.
2. Confirm desired connection type with the appropriate keyboard command.

Switching operations from the own CON Device can only be performed on CPU Devices that are available in the **CPU Devices** list.



Listed CPU Devices highlighted in red color are currently connected in Private Mode and are blocked by the connected CON Device.

Switching via Selection List for CPU Devices

The matrix offers the ability to execute KVM switching operations by means of a selection list for CPU Devices next to the OSD in full screen.

In order to use the selection list for CPU Devices, proceed as follows:

1. Activate the **Enable CPU Selection List** option in the **Configuration** menu for those consoles where the selection list for CPU Devices should be available.
2. Execute the key sequence for opening the OSD. The selection list immediately appears in the preset position of the extender OSD.



Pressing <F8> hides inactive CPU Devices to provide a clearer overview.

3. Execute the desired switching operation by pressing the respective key (see Chapter 6.3, Page 211).
In order to prevent a switching operation and access OSD, press <F7>.
In order to close the selection list, press <Esc>.

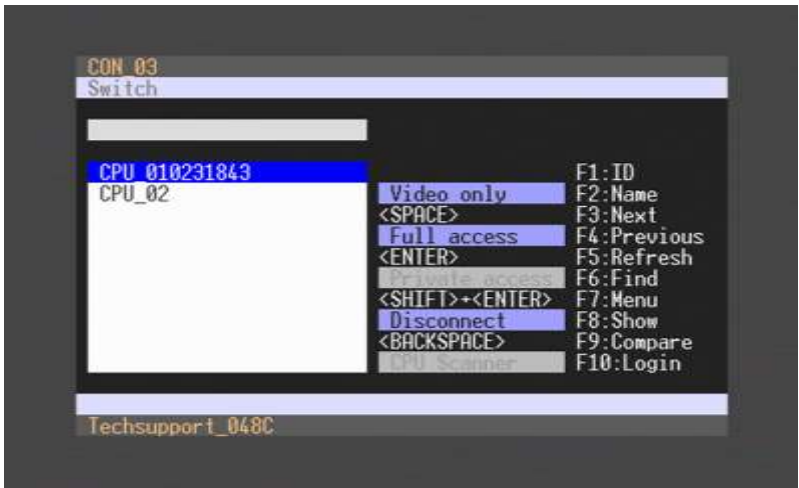

Example view **Selection list CPU Devices**

Activating the automatical Scan Mode for CPU Devices

The matrix offers the ability to use a scan mode based on the favorite list of each console or user. Scan mode allows the matrix to switch in sequence between the CPU Devices in the favorite list within a predefined time. All scans are performed in video only mode.

To configure scan mode, refer to Chapter 5.13.1, Page 140.

You have the following option to activate the scan mode:



In order to activate scan mode, proceed as follows:

1. Define a favorite list for the respective CON Device or user (see Chapter 5.13.4, Page 152 for CON Devices or see Chapter 5.5.2, Page 110 for users)
2. Start Command Mode with the 'Hot Key' and press <o> to open OSD.
3. Select one of the CPU Devices in the CPU selection list that are defined in your favorite list.
4. Confirm your selection by pressing the **CPU Scanner** button. The scan will automatically start.
5. If you have enabled the **Force CPU Scan** option, the scan will automatically start after switching the respective CON Device to any CPU Device from the favorite list without the need to press the **CPU Scanner** button.

6.3 Extended Switching

You have the following options to perform switching operation with the Draco tera:



OSD

To switch any console to any available CPU, proceed as follows:

➔ Select **Extended Switch** in the main menu.



Pressing <F8> hides inactive CPU Devices to provide a clearer overview.

```

admin@CON_010190841 (1044/2136) ihse
Extended Switch F1:ID F2:Name F3:Next F4:Previous F5:Refresh F6:Find F9:Compare ESC
CON Devices CON/CPU Data
03004 CON_010190841
03002 CON_040062140
03003 CON_040112302
03001 CON_040212434
CON device CPU device
03004 CON_010190841
CON assigned CPU assigned
CPU connected CON connected
Status Status
ONLINE
EXT list EXT list
010190841 0001 EXT_010190841

Switch Select the CON device for extended switching
<ENTER>
Disconnect Disconnect the CON device ...
<BACKSPACE>

SWITCH_01:1 Draco tera

```

Menu *Extended Switch*

1. Select in the **CON Devices** list on the left hand side that one that should be switched to a CPU Device and open it by pressing <Enter>.
2. Select in the **CPU Devices** list on the left hand side that one that should be connected to the open CON Device.

3. Confirm the desired connection type with the respective keyboard command.

Switching operations from the user's CON Device can only be performed on CPU Devices that are available in the **CPU Devices** list.

The following information is shown in this menu:

Field	Description
CON device	Assigned physical extender unit (CON Unit)
CON assigned	Virtual CON Device that is assigned to the real CON Device
CPU connected	Currently connected CPU Device
CON status	Current connection status (CON Device)
EXT list	List of all available physical extender units (CON Units)
CPU device	Assigned physical extender unit (CPU Unit)
CPU assigned	Real CPU Device that is assigned to a virtual CPU Device
CON connected	Currently connected CON Device
CPU status	Current connection status (CPU Device)
EXT list	List of all available physical extender units (CPU Units)

You can select the following switching functions:

Function	Keyboard Command
Set a video only connection.	<Space>
Set a KVM connection.	<Enter>
Set a KVM connection in Private Mode (video sharing disabled).	<Shift> + <Enter>
Disconnect own CON Device from CPU Device.	<Backspace>

Java Tool

You have two options to perform switching operations for the Draco terra via Java Tool:

Possibility 1:

➔ Select **Control > Extended Switch** in the task area.

Name	Console	Full Access	Video Access	CPU
020001	020001	<input type="checkbox"/>	<input type="checkbox"/>	
020002	020002	<input type="checkbox"/>	<input type="checkbox"/>	
020003	020003	<input type="checkbox"/>	<input type="checkbox"/>	
020004	020004	<input type="checkbox"/>	<input type="checkbox"/>	
020005	020005	<input type="checkbox"/>	<input type="checkbox"/>	
020006	020006	<input type="checkbox"/>	<input type="checkbox"/>	
020007	020007	<input type="checkbox"/>	<input type="checkbox"/>	
020008	020008	<input type="checkbox"/>	<input type="checkbox"/>	
020009	020009	<input type="checkbox"/>	<input type="checkbox"/>	
020010	020010	<input type="checkbox"/>	<input type="checkbox"/>	
020011	020011	<input type="checkbox"/>	<input type="checkbox"/>	
020012	020012	<input type="checkbox"/>	<input type="checkbox"/>	
020013	020013	<input type="checkbox"/>	<input type="checkbox"/>	
020014	020014	<input type="checkbox"/>	<input type="checkbox"/>	
020015	020015	<input type="checkbox"/>	<input type="checkbox"/>	
020016	020016	<input type="checkbox"/>	<input type="checkbox"/>	
020017	020017	<input type="checkbox"/>	<input type="checkbox"/>	
020018	020018	<input type="checkbox"/>	<input type="checkbox"/>	
020019	020019	<input type="checkbox"/>	<input type="checkbox"/>	
020020	020020	<input type="checkbox"/>	<input type="checkbox"/>	
020021	020021	<input type="checkbox"/>	<input type="checkbox"/>	
020022	020022	<input type="checkbox"/>	<input type="checkbox"/>	
020023	020023	<input type="checkbox"/>	<input type="checkbox"/>	
020024	020024	<input type="checkbox"/>	<input type="checkbox"/>	
020025	020025	<input type="checkbox"/>	<input type="checkbox"/>	
020026	020026	<input type="checkbox"/>	<input type="checkbox"/>	
020027	020027	<input type="checkbox"/>	<input type="checkbox"/>	
020028	020028	<input type="checkbox"/>	<input type="checkbox"/>	
020029	020029	<input type="checkbox"/>	<input type="checkbox"/>	
020030	020030	<input type="checkbox"/>	<input type="checkbox"/>	
020031	020031	<input type="checkbox"/>	<input type="checkbox"/>	
020032	020032	<input type="checkbox"/>	<input type="checkbox"/>	
020033	020033	<input type="checkbox"/>	<input type="checkbox"/>	
020034	020034	<input type="checkbox"/>	<input type="checkbox"/>	
020035	020035	<input type="checkbox"/>	<input type="checkbox"/>	
020036	020036	<input type="checkbox"/>	<input type="checkbox"/>	
020037	020037	<input type="checkbox"/>	<input type="checkbox"/>	
020038	020038	<input type="checkbox"/>	<input type="checkbox"/>	
020039	020039	<input type="checkbox"/>	<input type="checkbox"/>	
020040	020040	<input type="checkbox"/>	<input type="checkbox"/>	
020041	020041	<input type="checkbox"/>	<input type="checkbox"/>	
020042	020042	<input type="checkbox"/>	<input type="checkbox"/>	
020043	020043	<input type="checkbox"/>	<input type="checkbox"/>	
020044	020044	<input type="checkbox"/>	<input type="checkbox"/>	
020045	020045	<input type="checkbox"/>	<input type="checkbox"/>	
020046	020046	<input type="checkbox"/>	<input type="checkbox"/>	
020047	020047	<input type="checkbox"/>	<input type="checkbox"/>	
020048	020048	<input type="checkbox"/>	<input type="checkbox"/>	
020049	020049	<input type="checkbox"/>	<input type="checkbox"/>	
020050	020050	<input type="checkbox"/>	<input type="checkbox"/>	
020051	020051	<input type="checkbox"/>	<input type="checkbox"/>	
020052	020052	<input type="checkbox"/>	<input type="checkbox"/>	
020053	020053	<input type="checkbox"/>	<input type="checkbox"/>	
020054	020054	<input type="checkbox"/>	<input type="checkbox"/>	
020055	020055	<input type="checkbox"/>	<input type="checkbox"/>	
020056	020056	<input type="checkbox"/>	<input type="checkbox"/>	
020057	020057	<input type="checkbox"/>	<input type="checkbox"/>	
020058	020058	<input type="checkbox"/>	<input type="checkbox"/>	
020059	020059	<input type="checkbox"/>	<input type="checkbox"/>	
020060	020060	<input type="checkbox"/>	<input type="checkbox"/>	

Menu **Control – Extended Switch**

All connected consoles and the associated CPU connections are shown in columns in the working area in this menu.



Switching operations can only be performed in online mode. That means an active network connection is required between the matrix and the Java Tool.



- ➔ In order to set a **KVM connection** between a console and a CPU, double-click on the corresponding selection box within the **Full Access** column and select the requested CPU.
- ➔ In order to set a **video connection** between a console and a CPU, double-click on the corresponding selection box within the **Video Only** column and select the requested CPU.

- ➔ In order to set a **Private Mode** connection between a console and a CPU, double-click on the corresponding selection box within the **Private Mode** column and select the requested CPU.



If a CPU console does not have access rights, it will not appear in the list.

The following symbols are shown in the connection overview:

Symbol	Description
	CON Device is connected via Shared Access with at least one further console to the same CPU. The CON Device has Full Access at the moment.
	CON Device is connected via Shared Access with at least one further console to the same CPU. The CON Device has a Video Access connection at the moment.

You can use the following buttons to perform a switching operation:

Button	Function
Send	Send effected switching operations to the matrix
Reset	Disconnect all existing connections within the matrix
Reload	Reload switching status



When the **Auto Send** function in the left lower corner of the work area is ticked, switching operations will be completed immediately without user confirmation by means of the **Send** button.

When the **Hide Devices w/o Extender Assignment** function in the left lower corner of the work area is ticked, only CON and CPU Devices that are assigned to extenders are shown.

Possibility 2:

- ➔ Select **View > Matrix** in the task area or select **View > Port** when using a Matrix Grid.

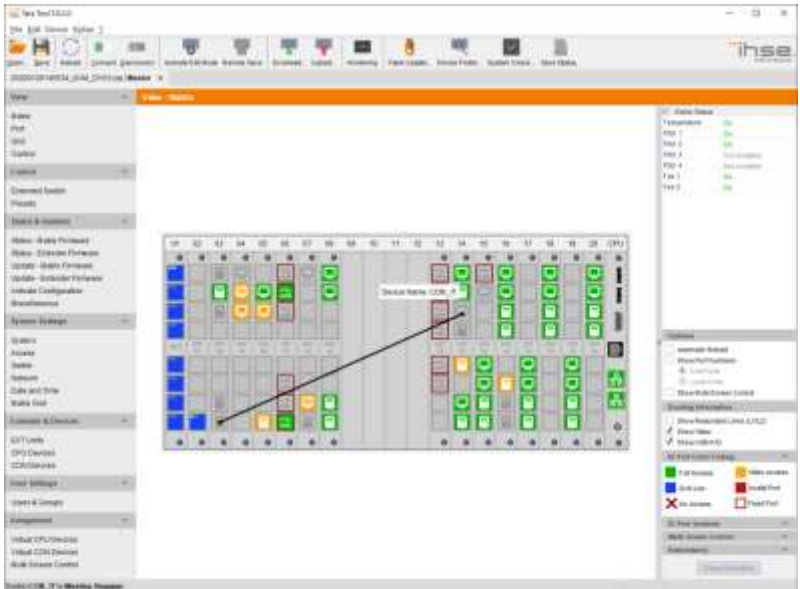

Menu **View - Matrix**

In order to perform switching operations between CON and CPU Devices proceed as follows:

1. Move the mouse cursor to the port that has to be switched.
2. Hold down the left mouse button and move the cursor to the port that has to be connected to the initial port. The current cursor movement will be displayed by a black auxiliary line.
3. Release the left mouse button. A popup to select the available switching type (**Full Access**, **Video Access** or **Private Mode**) will be opened.
4. Select the desired switching type. The switching operation will be immediately executed. At the same time all extender units that are assigned to the involved devices will be switched.



If a port is shown with a red cross on **Matrix View**, the console does not have access rights to the CPU connected to that port.

In order to disconnect existing connection between CON and CPU Devices proceed as follows:

1. Click on the port that is to be disconnected by using the right mouse button.
2. Select the **Disconnect** function in the popup that appears. The connected ports will be immediately disconnected. At the same time all further connections of the extenders assigned to the involved devices will be disconnected.

6.4 Switching via Macro List

Next to executing macros via function keys <F1>-<F16>, they can also be executed via Macro List in the OSD. At the same time this specific list offers the possibility to see the content of the various macros including the single commands before executing them. There are displayed 16 of the total 32 macros per page.

You have the following option to to use the Macro List:



OSD

➔ Select **Macro List** in the main menu.

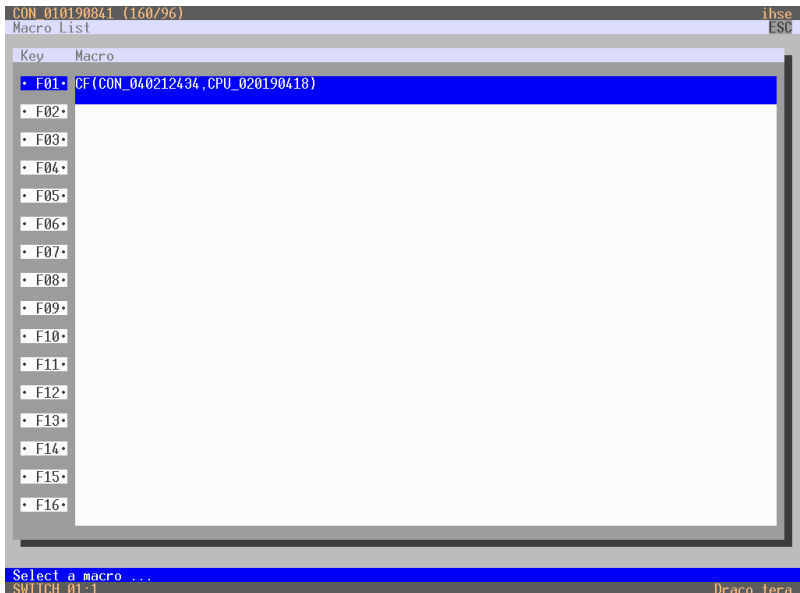

Menu – **Macro List**

1. Make sure that you have already configured CON or user macros.
2. Select the respective macro in the list that you want to execute. If you want to execute a macro 17-32 (<Shift> <F1>-<F16>), press the key <Page Down> and select the macro afterwards.
3. Execute the macro by pressing the key <Enter>.

The macro will be immediately executed.



If the Macro List should be directly displayed upon opening OSD, activate the option **Show Macro List** in the menu **Configuration > CON Devices** for the respective CON Devices.

6.5 Switching of single Extenders within Devices

You can independently switch single extenders within configurations consisting of CON and CPU devices with multiple extenders.

You have the following option to switch single extenders:



OSD

In order to switch a single extender a device with multiple extender, proceed as follows:

- ➔ Select **Switch** in the main menu.

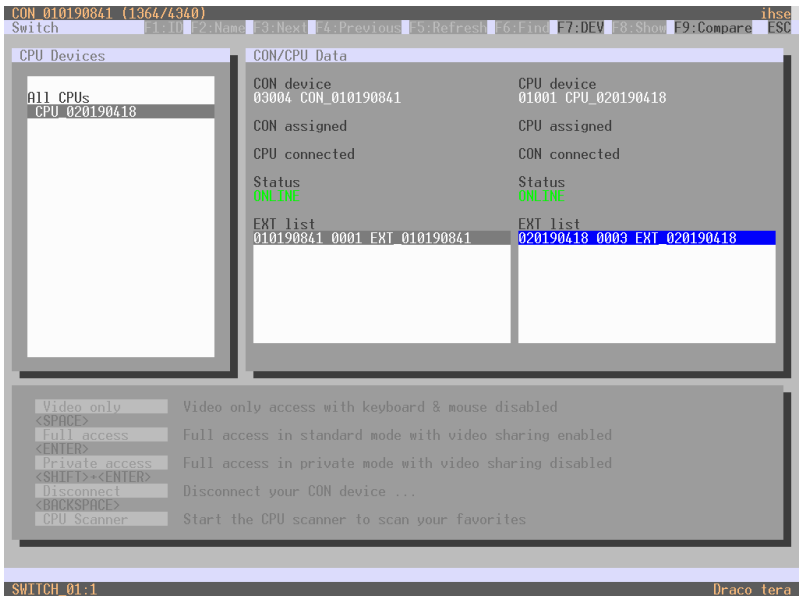

Menu – Switch

1. Select the respective CPU Device in the CPU selection list containing the extender you want to have access to.
2. Press the function key <F7> on the keyboard. The standard will change into the switching mode for single extenders.
3. Select the extender you want to switch within your CON Device.
4. Access the extender list of the selected CPU Device by pressing the key <Tab>.
5. Select the CPU extender you want to switch to and press the key <Space> in order to execute the switching operation.



Switching of single extenders from a Device is only possible in video only mode. Single extenders of a Device that are already switched will be highlighted with "!".

6.6 CON Switch

KVM extender CON Units connected to a local source (computer, CPU) can be locally switched via the matrix. Switching is performed between the local source and the KVM connection and can be executed via 'Hot Keys' or via OSD.

If you switch to the local source, the KVM connection will be automatically disconnected.



When using CON Units with the possibility to connect a local source (computer, CPU) in a Multi-Screen Control environment, the local switching will be disabled.

You have the following option to switch to the local source:



OSD

➔ Select **Switch** in the main menu.

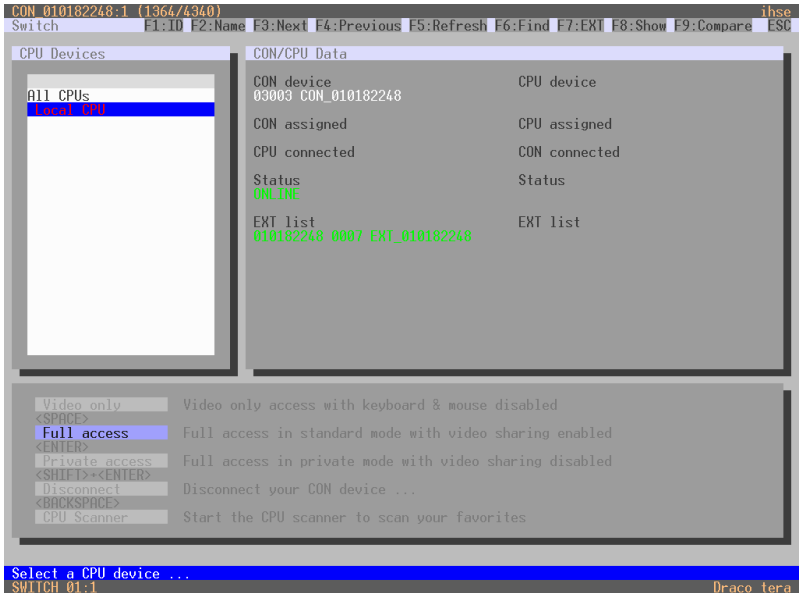

Menu – CON Switch

In order to switch to a local source, proceed as follows:

1. If you are not in the **Switch** menu of the OSD, start Command Mode with the 'Hot Key' (see Chapter 5.1, Page 61).
2. Press <0> to open OSD.
You will see a list of all available CPUs as a start menu.
3. Switch to the CPU in the **Local CPU** list.
The switching operation to the local source will be performed immediately.



The local source (computer, CPU) will be only shown in the OSD, if the connected CON Unit includes the option for a local connection.

As an alternative, the following keyboard commands are available to switch to the local source:

Function	Keyboard Command
Switching to extender connection	<'Hot Key'>, <k>, <1>, <Enter>
Switching to extender connection 2 (only with redundant CON Units)	<'Hot Key'>, <k>, <2>, <Enter>
Switching to the local source (computer, CPU)	<'Hot Key'>, <l>, <Enter>

6.7 Multi-Screen Control

The Multi-Screen function contains a switching of the USB-HID signal between different statically connected sources (computer, CPU) within a CON Device and can be performed in two different ways:

Switching via Mouse

The switching of the USB-HID signal can be made by a movement of the mouse pointer beyond the edge of the current display to a neighboring display (see Chapter 5.13.7, Page 161).

In order to perform a switching operation by movement of the mouse pointer, proceed as follows:

1. Move the mouse pointer to that edge of the display which borders vertically or horizontally to the neighboring display.
2. Move the mouse pointer beyond the edge of the display. The mouse pointer will appear on the adjacent display.
The switching operation has been performed and the USB-HID signal will be now available at the target display.

Switching via Keyboard

Switching of the USB-HID signal can also be achieved using the keyboard (configuration see Chapter 5.13.7, Page 161).

In order to perform a switching operation via keyboard command, proceed as follows:

1. Start Command Mode with the 'Hot Key' (see Chapter 5.1, Page 61).
2. Select the target display by pressing the respective key on the numeric pad of the keyboard.
The switching operation will be performed and the USB-HID signal will be available at the target display.

You can select the following switching operations:

Keyboard Command	Function
<current 'Hot Key'>, <Num 0>	Switching of the USB-HID signal to the own display (CON Unit with keyboard and mouse)
<current 'Hot Key'>, <Num 1>	Switching of the USB-HID signals to display #1
<current 'Hot Key'>, <Num 2>	Switching of the USB-HID signals to display #2
<current 'Hot Key'>, <Num 3>	Switching of the USB-HID signals to display #3
<current 'Hot Key'>, <Num 4>	Switching of the USB-HID signals to display #4

6.8 USB 2.0 Switching

Switching of USB 2.0 extender basically works like switching of KVM extenders. The following scenarios to switch USB 2.0 extenders are possible.

1. An extender unit with USB 2.0 will be created and assigned to an already existing device with existing KVM extender units (see Chapter 5.10, Page 132 or Chapter 5.13.1, Page 140).
2. A separate device for the extender unit with USB 2.0 will be created without assigning a KVM extender unit to that device. This possibility offers a separate switching of the USB 2.0 signal (see Chapter 5.10, Page 132 or Chapter 5.13.1, Page 140).



Switching of USB 2.0 signals uses Extended Switching functionality (see Chapter 6.3, Page 211).

When using parallel operation within the matrix, set the Release Time in the **System Settings > Switch** menu to 10 s or more (see Chapter 5.13.6, Page 158). Otherwise the connection of the USB 2.0 extender will not be established due to security and stability reasons.

6.9 Presets

Predefined macros to switch the matrix without loading a new configuration can be created and activated in this menu.

You have the following option to access the menu:



➔ Select **Control > Presets** in the task area.

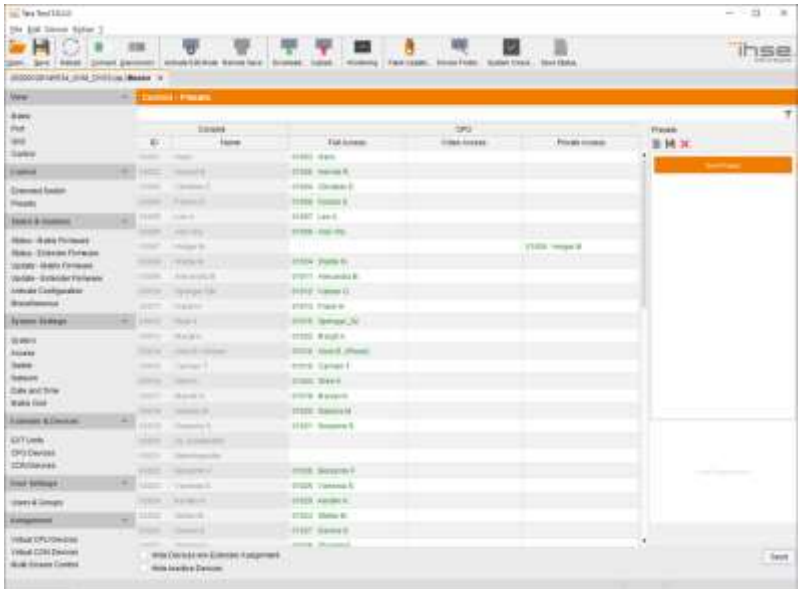

Menu **Control – Presets**

To create a new switch macro proceed as follows:

1. Open a new switch macro by pressing on the **New** symbol in the right column of the working area.
 You are asked if the existing connections should be taken over for the new switch macro.
2. Set the desired switching operations in the corresponding columns (**Full Access**, **Video Only** or **Private Mode**) by using a double click on the appropriate selection box or use the function for a disconnect (**Disconnect CPU**).

3. Save the created switch macro by clicking the **Save** symbol in the right column of the working area.
A save dialog will be opened.
4. Enter a name or the new switch macro and confirm by pressing the **Ok** button in the save dialog.
5. By clicking on a selected switch macro with the right mouse button, you can create a copy of the current switch macro when using the **Save as...** option.
6. Previously saved macros can be deleted by pressing the **Delete** symbol.

To load a predefined switching, proceed as follows:

1. Select the switch macro in the right column of the working area that has to be loaded.
2. Activate the selected switch macro by pressing the **Send** button on the bottom right of the working area.



A predefined switch macro can only be activated in online mode.

When loading presets, only those switching operations that are compliant with the hardware and the configuration of the currently used matrix are taken into account.

6.10 Tera Viewer

This function presents an optionally available upgrade for Draco tera KVM matrices and allows an IP based preview of various video signals. For this application, additional hardware in terms of an H264 IP encoder is required. The encoder includes 2 IP access points for the display of a live video and the video wall based on the configured layout.

You have the following option to access the menu:



The encoder is preconfigured when being shipped and has the IP address 192.168.100.97 per default.

Switching Operations

To use the function Switch & Preview proceed as follows:

1. Select the button Connect in the symbol bar and connect to the matrix that you would like to use.
2. Open a preconfigured monitor layout to be used via **Open Layout...** in the symbol bar. The layout file contains the file ending .dtl. If there is not layout available yet, it can be created via Layout Designer.
3. To perform a switching operation, highlight the respective source (CPU Device) in the lower sector of the working area and move it to the intended CON Device in the monitor layout (drag & drop).
4. To copy an existing connection to another monitor, highlight an already connected monitor (CON Device) and move it to the new monitor (drag & drop).
5. To disconnect an existing connection, highlight the respective CON Device and move it to the symbol **Disconnect**.

The connection will be immediately disconnected.



Menu – Default Layout



If a source (CPU Device) or a monitor (CON Device) is highlighted, the respective live video appears in the live view that can be found in the right lower corner.

New Monitor Layout

To create a new monitor layout proceed as follows:

1. Press the button **Open Designer...** in the symbol bar. To open the designer, an active connection to the matrix is obligatory.
The designer will be opened.
2. Press the button **New** in the symbol bar of the designer.
A new design will be opened.
3. Create new screens for your layout by pressing the button **Add Screen...** in the symbol bar.
A popup will be opened.
4. Select the **CON Device** in the popup that should be used for the intended screen. Define the following specifications if required:
 - **Ratio:** aspect ratio
 - **Title Position:** position of the monitor label
 - **Orientation:** monitor orientation
5. Repeat step 4. for each new monitor.
6. To add switchable sources (computer/CPU) to the layout, press the button **Add / Remove CPU...**
7. Select the CPUs in the popup that should be used and insert those into the list **CPU assigned**.
8. Press the button **Settings** in the symbol bar to make further necessary settings.
9. Enter the appropriate URL of the encoder under **Preview URL** that should be used for the video preview.
(default: **rtsp://192.168.100.97/live1**)
10. Enter the appropriate URL of the encoder under **Screen URL** that should be used for the monitor layout.
(Default: **rtsp://192.168.100.97/live2**)
11. Select the respective **Preview** und **Screen CON Devices** that are connected to the encoder and confirm your settings with **Ok**.

12. Press the button **Layout Check...** in the symbol bar to verify your new layout.
A summary for the new layout will appear.
13. Save your created layout by pressing the button **Save** and follow the instructions. If you externally store a layout, it will obtain the file ending .dtl.

Default Monitor Layout

To define a default layout, proceed as follows

1. Open an already created layout.
2. Press the button **Set As Default** in the symbol bar.
The open layout will be stored as default layout.
3. To delete a default layout, press the button **Delete Default** in the symbol bar.
4. If there is open another layout other than the default layout, you can display the default layout by pressing the button **Load Default** in the symbol bar.

6.11 Redundancy Function

KVM extenders with redundant connectors for interconnect cables can be simultaneously operated with both connectors at a single Matrix or a Matrix Grid (from firmware version V04.00).

The connector labeled with **Link 1** at the KVM extender is meant for the primary connection. If the connection on CON or CPU Unit side is interrupted due to any problem, the connection will be automatically re-established through the second connector labeled with **Link 2**.

For this kind of redundancy function, there is no need for any configuration of the KVM matrix or the KVM extenders.

If needed, you can manually switch between **Link 1** and **Link 2** at the CON Unit (see Chapter 6.6, Page 219).

You have the following possibilities to check the status of redundancy:



OSD

➔ Select **Switch** in the main menu.

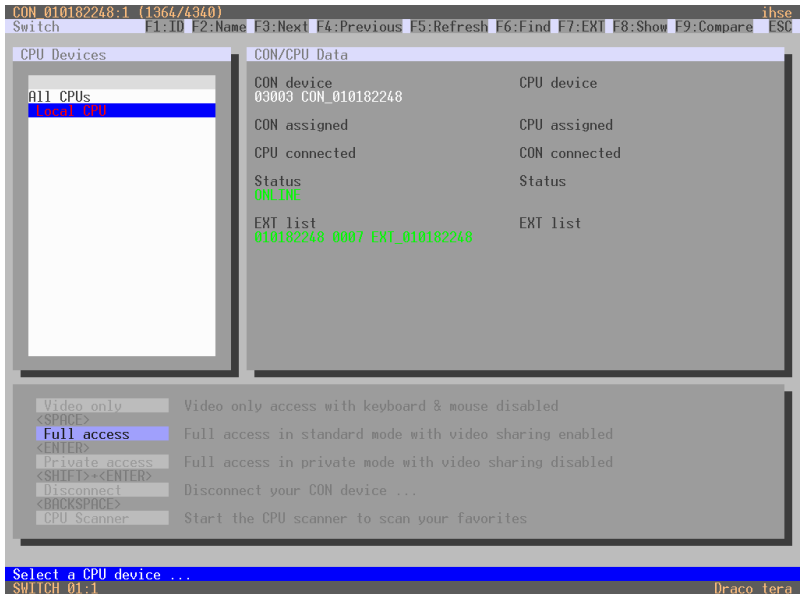

Menu – Switch

When using redundant KVM extenders, the respectively active connector is shown in this view under **EXT list** in the field **CON/CPU Data**. If the first connector (**Link 1**) is active, it will be highlighted with **:1** behind the respective extender. If the second connector (**Link 2**) is active, this will be highlighted with **:2**.

Java Tool

➔ Select **View > Matrix** in the task area.

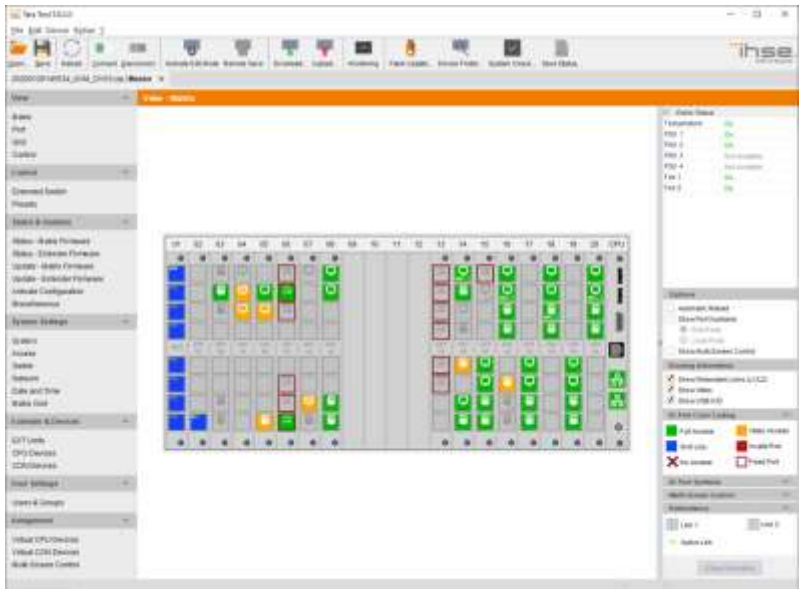

Menu View - Matrix

In order to check the connection status of the redundant KVM extenders, proceed as follows:

1. Activate the checkbox **Show Redundant Links (L1/L2)** under **Routing Information** on the right side of the working area.
2. Open the menu **Redundancy** on the right side of the working area, in order to receive the respective legend information.

Redundant connectors are highlighted in the **Matrix View** with **L1** and **L2**. The respectively active link is highlighted with a light green label.

6.12 Serial Interface



The Draco tera offers the option to switch via a serial interface (RS232). Detailed information for the serial interface and the corresponding switching commands are available in form of an API (application programming interface) upon request.

6.13 Power On and Power Down Functions

6.13.1 Restart

You have the following options to perform a restart:



OSD

1. Select **Configuration > Restart Matrix, Restart IO Board or Restart CPU Board** in the main menu to restart either the matrix, the I/O boards or the CPU board.
2. Confirm the selection with **Okay** button.

The matrix, the I/O boards or the CPU board will be restarted with the current settings.

Java Tool

- Select **Device > Advanced Service > Restart Matrix** in the menu bar.

The matrix will be restarted with the current settings.



The boot process of the matrix might take longer, if there is no physical network connection available.

6.13.2 Factory Reset

You have the following option to perform a reset of the system:



If you perform a (factory) reset, all current settings and all configurations stored in the matrix will be lost. This also applies to the network parameters (reset to DHCP) and the admin password.



If a firmware update has been installed since the delivery, the matrix will be set to the state defined there.

OSD

1. Select **Configuration > Factory Reset** in the main menu.
2. Confirm the selection with the **Okay** button.

The matrix will be reset to factory settings.

6.13.3 Power Down

You have the following option to perform a shut down of the system or single components:



OSD

In order to shut down the system, proceed as follows:

1. Select **Configuration > Shut down Matrix** in the main menu.
2. Confirm the selection with the **Okay** button.

The matrix will be shut down.



The fans will be switched to maximum speed after the shut down. Then the matrix can be disconnected from the power supply.

In order to shut down an I/O board, proceed as follows:

1. Select **Configuration > Shut Down IO Board** in the main menu.
2. Confirm the selection with the **Okay** button.

The I/O board will be shut down.

6.14 Summary of Keyboard Commands

In the following you find a summary of keyboard commands that can activate extender and matrix functions after executing the 'Hot Key'.

Extender

Keyboard Command	Description
<'Hot Key'>, <a>	Download of DDC information for the monitor connected to the CON Unit into the CPU Unit
<'Hot Key'>, <k>, <1>, <Enter>	Switch to the KVM connection 1 (only with HDMI CON Units with available connection for a local source)
<'Hot Key'>, <k>, <2>, <Enter>	Switch to the KVM connection 2 (only with HDMI CON Units with available connection for a local source and a redundant interconnection)
<'Hot Key'>, <l>, <Enter>	Switch to local source (computer, CPU) (only with HDMI CON Units with available connection for a local source)
<'Hot Key'>, <h>, <w>, <Enter>	USB-HID Ghosting: Write device descriptions of the input devices connected to the CON Unit into the CPU Unit. Activate the emulation in the CPU Unit.
<'Hot Key'>, <h>, <e>, <Enter>	Activate the emulation of already stored device descriptions in the CPU Unit
<'Hot Key'>, <h>, <d>, <Enter>	Deactivate the emulation of active device descriptions in the CPU Unit. The input devices connected to the CON Unit will be passed transparently to the source (computer, CPU).
<'Hot Key'>, <h>, <r>, <Enter>	Deactivate the emulation of active device descriptions in the CPU Unit. Delete the descriptions out of the CPU Unit. The input devices connected to the CON Unit will be passed transparently to the source (computer, CPU).
<'Hot Key'>, <d>, <1>, <Enter>	Switch to video channel 1 of the Dual-Head CPU Unit (482 series only)
<'Hot Key'>, <d>, <2>, <Enter>	Switch to video channel 2 of the Dual-Head CPU Unit (482 series only)

Matrix

Keyboard Command	Description
<'Hot Key'>, <0>	Open OSD
<'Hot Key'>, <m>, <0>	Open OSD of the master matrix in a cascaded environment
<'Hot Key'>, <s>, <0>	Open OSD of the sub matrix in a cascaded environment
<'Hot Key'>, <Backspace>	Close the current connection of the own console
<'Hot Key'>, <p>	Switch back to the previous connected source (computer, CPU) with a KVM connection
<'Hot Key'>, <1> ... <16>, <Enter> (<Space> or <Left Shift> + <Enter>)	Switch to a source (computer, CPU) stored in the Favorite List with a KVM connection (video only or Private-Mode connection)
<'Hot Key'>, <F1> ... <F16>	Execute a predefined macro (macro 1-16)
<'Hot Key'>, <Left Shift> + <F17> ... <F32>	Execute a predefined macro (macro 17-32)
<'Hot Key'>, <c>, <new 'Hot Key'-Code>, <Enter>	Change the 'Hot Key' according to the predefined 'Hot Key' table
<'Hot Key'>, <c>, <0>, <new 'Hot Key' key >, <Enter>	Define freely selectable 'Hot Key'
<'Hot Key'>, <f>, <new 'Hot Key'-Code>, <Enter>	Change the 'Hot Key' for direct OSD access according to the predefined 'Hot Key' table
<'Hot Key'>, <f>, <0>, <new 'Hot Key' key>, <Enter>	Define freely selectable 'Hot Key' for direct OSD access
<'Hot Key'>, <Num 0>	Switch the USB-HID signal to the user's display (CON Unit with keyboard and mouse)
<'Hot Key'>, <Num 1>	Switching of the USB-HID signals to display #1
<'Hot Key'>, <Num 2>	Switching of the USB-HID signals to display #2
<'Hot Key'>, <Num 3>	Switching of the USB-HID signals to display #3
<'Hot Key'>, <Num 4>	Switching of the USB-HID signals to display #4

7 Specifications

7.1 Interfaces

7.1.1 DVI-D Single Link

The video interface supports the DVI-D protocol. All signals that comply with DVI-D Single Link norm can be transmitted. This includes monitor resolutions such as 1920x1200@60Hz, Full HD (1080p) or 2K HD (up to 2048x1152). Data rate is limited to 165 MPixel/s.

7.1.2 USB-HID

Our devices with USB-HID interface support a maximum of two devices with USB-HID protocol. Each USB-HID port provides a maximum current of 100 mA.

Keyboard

Compatible with most USB keyboards. Certain keyboards with additional functions may require custom firmware to operate. Keyboards with an integral USB Hub (Mac keyboards e.g.) are also supported.

Mouse

Compatible with most 2-button, 3-button and scroll mice.

Other USB-HID devices

The proprietary USB emulation also supports certain other USB-HID devices, such as specific touch screens, graphic tablets, barcode scanners or special keyboards. Support cannot be guaranteed, however, for every USB-HID device.

Extension

If it is required to extend the USB-HID signals on CON or CPU side (e.g. mounting requirement), the signals can be extended either via a 3.0 m A-B cable (247-U2) or a 3.0 m USB A-A extension cable (436-USB20).

The compatibility to other extension cables cannot be guaranteed.



Only two USB-HID devices are supported concurrently, such as keyboard and mouse or keyboard and touch screen. A hub is allowed, but it does not increase the number of HID devices allowed.

To support other USB 'non-HID' devices, such as scanners, web cams or memory devices, choose our devices with transparent USB support.

7.1.3 RJ45 (Network)

The communication of the Cat X devices requires a 100BASE-T connection.

The cabling has to be done according to EIA/TIA-568-B (100BASE-T) with RJ45 connectors at both ends. All four wire pairs are used in both directions. The cabling is suitable for a full duplex operation. For the cable connection to a source (computer, CPU), a crossed network cable (cross cable) has to be used.

7.1.4 RS-232 (Serial)

Communication takes place with a transmission speed of up to 115.2 Kbaud, regardless of the file format. The transmission takes place with eight data bits and a stop bit, but without a parity bit. Limited hardware handshake (DSR) is possible.

7.1.5 RJ45 (Interconnect)

Communication between Cat X devices requires a 1000BASE-T connection.

Connector wiring must comply with EIA/TIA-568-B (1000BASE-T), with RJ45 connectors at both ends. All four cable wire pairs are used.

7.1.6 Fiber SFP Type LC (Interconnect)

Communication of fiber devices is performed via Gigabit SFPs that are connected to suitable fibers fitted with connectors type LC (see Chapter 7.2.2, Page 238).



The correct function of the device can only be guaranteed with SFPs provided by the manufacturer.



SFP modules can be damaged by electrostatic discharge (ESD).

→ Please consider ESD handling specifications.

7.1.7 SDI (Interconnect)

Communication of the SDI devices requires a mini coax connection with HD-BNC connectors or 3G SFPs with transmission speeds of 0.36 Gbit/s (SD-SDI, SMPTE 259M), 1.485 Gbit/s (HD-SDI, SMPTE 292M) and 2.97 Gbit/s (3G SDI).

7.2 Interconnect Cable

7.2.1 Cat X



A point-to-point connection is required. Operation with several patch fields is possible. Routing over an active network component, such as an Ethernet Hub, Router or Matrix, is not allowed.

→ Avoid routing Cat X cables along power cables.



To maintain regulatory EMC compliance, correctly installed shielded Cat X cable must be used throughout the interconnection link.



To maintain regulatory EMC compliance, all Cat X cables need to carry ferrites on both cable ends close to the device. Failure to do so will result to invalidity of the EU declaration of conformity.

Type of Interconnect Cable

The Draco tera requires interconnect cabling specified for Gigabit Ethernet (1000BASE-T). The use of solid-core (AWG24), shielded, Cat 5e (or better) is recommended.

Cat X Solid-Core Cable AWG24	S/UTP (Cat 5e) cable according to EIA/TIA-568-B. Four pairs of wires AWG24. Connection according to EIA/TIA-568-B (1000BASE-T).
Cat X Patch Cable AWG26/8	S/UTP (Cat 5e) cable according to EIA/TIA-568-B. Four pairs of wires AWG26/8. Connection according to EIA/TIA-568-B (1000BASE-T).



The use of flexible cables (patch cables) type AWG26/8 is possible, however the maximum possible extension distance is halved.

Maximum Acceptable Cable Length

Cat X Installation Cable AWG24	140 m (400 ft)
Cat X Patch Cable AWG26/8	70 m (200 ft)

7.2.2 Fiber



A point-to-point connection is necessary. Operation with multiple patch panels is allowed. Routing over active network components, such as Ethernet Hubs, Matrixes or Routers, is not allowed.

Type of Interconnect Cable

(Cable notations according to VDE)

Type of cable	Specifications
Single-mode 9µm	<ul style="list-style-type: none"> • Two fibers 9µm • I-V(ZN)H 2E9 (in-house patch cable) • I-V(ZN)HH 2E9 (in-house breakout cable) • I/AD(ZN)H 4E9 (in-house or outdoor breakout cable, resistant) • A/DQ(ZN)B2Y 4G9 (outdoor cable, with protection against rodents)
Multi-mode 50µm	<ul style="list-style-type: none"> • Two fibers 50µm • I-V(ZN)H 2G50 (in-house patch cable) • I/AD(ZN)H 4G50 (in-house or outdoor breakout cable, resistant)
Multi-mode 62,5µm	<ul style="list-style-type: none"> • Two fibers 62,5µm • I-V(ZN)HH 2G62,5 (in-house breakout cable) • A/DQ(ZN)B2Y 4G62,5 (outdoor cable, with protection against rodents)



Only use Single-mode connection cables for fiber connections that are based on 3G SFPs.

Maximum Acceptable Cable Length

Type of cable	1.25 Gbps	3.125 Gbps
Single-mode 9µm	10.000 m (32,800 ft)	5.000 m (16,400 ft)
Multi-mode 50µm (OM3)	1.000 m (3,280 ft)	500 m (1,640 ft)
Multi-mode 50µm	400 m (1,300 ft)	200 m (650 ft)
Multi-mode 62,5µm	200 m (650 ft)	100 m (325 ft)



If you use single-mode SFPs with multi-mode fibers, you normally can increase the maximum acceptable cable length.

Type of Connector

Connector	LC Connector
-----------	--------------

7.2.3 Coaxial



A point-to-point connection is necessary.

Type of Interconnect Cable

Cable Type	Specifications
Mini coaxial cable AWG 18	RG 6 impedance 75 Ω

Maximum Acceptable Cable Length

Band Width	Maximum Acceptable Cable Length
0.270 Gbit/s	400 m (1,312 ft)
1.485 Gbit/s	140 m (459 ft)
2.970 Gbit/s	120 m (394 ft)

Type of Connector

Connector	HD-BNC connector
-----------	------------------

7.3 Connector Pinouts

7.3.1 CPU Board

Connector DVI-D Single-Link

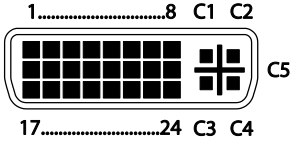

Pin	Signal	Pin	Signal	Pin	Signal
1	T.M.D.S data 2 -	9	T.M.D.S data 1 -	17	T.M.D.S data 0 -
2	T.M.D.S data 2 +	10	T.M.D.S data 1 +	18	T.M.D.S data 0 +
3	T.M.D.S data 2 GND	11	T.M.D.S data 1 GND	19	T.M.D.S data 0 GND
4	n.c.	12	n.c.	20	n.c.
5	n.c.	13	n.c.	21	n.c.
6	DDC Input (SCL)	14	+5VDC high impedance	22	T.M.D.S clock GND
7	DDC Output (SDA)	15	GND	23	T.M.D.S clock +
8	Internal use	16	Hot Plug recognition	24	T.M.D.S clock -
C1	Internal use			C3	Internal use
C2	n.c.	C5	GND	C4	Internal use

Connector USB Type A

Picture	Pin	Signal	Color
	1	VCC (+5VDC)	Red
	2	Data -	White
	3	Data +	Green
	4	GND	Black

D-Sub 9 (Serial) RS232, DCE

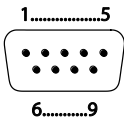
Picture	Pin	Signal	Pin	Signal
	1	n.c.	6	DSR
	2	RxD	7	RTS
	3	TxD	8	CTS
	4	DTR	9	n.c.
	5	GND		

RJ 10 (Serial), DCE

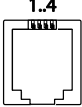
Picture	Pin	Signal
	1	TxD
	2	RxD
	3	n.c.
	4	GND

RJ45

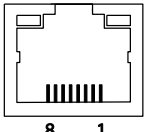
Picture	Pin	Signal	Pin	Signal
	1	D1+	5	n.c
	2	D1-	6	D2-
	3	D2+	7	n.c
	4	n.c	8	n.c

7.3.2 I/O Port Cat X

RJ45 (interconnect)

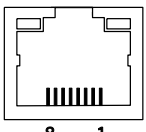
Picture	Pin	Signal	Pin	Signal
	1	D1+	5	D3-
	2	D1-	6	D2-
	3	D2+	7	D4+
	4	D3+	8	D4-

7.3.3 I/O Port SFP

Fiber SFP Typ LC

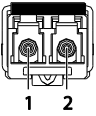
Picture	Diode	Signal
	1	Data OUT
	2	Data IN

7.3.4 I/O Port SDI

HD-BNC (SDI)

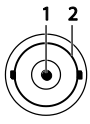
Picture	Pin	Signal
	1	Data IN
	2	GND

7.4 Power Supply

Maximum Current / Voltage

Draco tera 576/576S	29 A, 90-264 V _{ac} , 50/60 Hz
Draco tera 288	12 A, 100-240 V _{ac} , 50/60 Hz
Draco tera 160, 152	9 A, 100-240 V _{ac} , 50/60 Hz
Draco tera 80, 48	5 A, 100-240 V _{ac} , 50/60 Hz

Power Requirement

Draco tera 576	max. 635 W without I/O boards
Draco tera 576S	max. 300 W without I/O boards
Draco tera 288	max. 202 W without I/O boards
Draco tera 160, 152	max. 188 W without I/O boards
Draco tera 80	max. 99 W without I/O boards
Draco tera 48	max. 94 W without I/O boards
I/O Board	max. 13 W

7.5 Environmental Conditions

Operating Temperature	41 to 113 °F (5 to 45 °C)
Storage Temperature	-13 to 140 °F (-25 to 60 °C)
Relative Humidity	Max. 80% non-condensing
Operating Altitude	Max. 2.500 m (7,500 ft)

Noise Emission

Sound Pressure Level (SPL)	K480-576/576S: max. 65 dBA per fan
	K480-288: max. 65 dBA per fan
	K480-160: max. 65 dBA per fan
	K480-152: max. 65 dBA per fan
	K480-080: max. 46 dBA per fan
	K480-048: max. 58 dBA per fan

Heat Dissipation

Thermal output	Corresponds to power consumption in Watt (W)
-----------------------	--

7.6 Size

Draco tera 576/576S

Matrix	483 x 1108 x 435 mm (19.0" x 43.6" x 17.1")
Shipping Box	800 x 1200 x 950 mm (31.5" x 47.4" x 37.4")

Draco tera 288

Matrix	483 x 578 x 330 mm (19.0" x 22.8" x 12.0")
Shipping Box	650 x 680 x 760 mm (25.6" x 26.8" x 29.9")

Draco tera 160

Matrix	483 x 400 x 330 mm (19.0" x 15.8" x 12.0")
Shipping Box	650 x 680 x 540 mm (25.6" x 26.8" x 21.3")

Draco tera 152

Matrix	483 x 400 x 330 mm (19.0" x 15.8" x 12.0")
Shipping Box	650 x 680 x 540 mm (25.6" x 26.8" x 21.3")

Draco tera 80

Matrix	483 x 178 x 230 mm (19.0" x 7.0" x 9.1")
Shipping Box	640 x 570 x 360 mm (25.2" x 22.4" x 14.2")

Draco tera 48

Matrix	483 x 133 x 230 mm (19.0" x 5.3" x 9.1")
Shipping Box	640 x 570 x 316 mm (25.2" x 22.4" x 12.4")

7.7 Shipping Weight

Draco tera 576/576S

Matrix	81,1 kg (178.2 lb)
Shipping Box	88,1 kg (194.2 lb)

Draco tera 288

Matrix	34,6 kg (76.2 lb) fully equipped
Shipping Box	41,1 kg (90.6 lb)

Draco tera 160

Matrix	26,3 kg (60.0 lb) fully equipped
Shipping Box	31,7 kg (69.9 lb)

Draco tera 152

Matrix	26,3 kg (60.0 lb) fully equipped
Shipping Box	31,7 kg (69.9 lb)

Draco tera 80

Matrix	11,1 kg (24.5 lb) fully equipped
Shipping Box	15,6 kg (34.4 lb)

Draco tera 48

Matrix	8,9 kg (19.6 lb) fully equipped
Shipping Box	12,1 kg (26.7 lb)

7.8 MTBF

The following table contains the mean time between failure (MTBF) in power-on hours (POH). The estimate is based on the FIT rates of the parts included. FIT rates are based on normalized environmental conditions of T = 60°C and activation energy (E_a) of 0.7 eV. Calculations are based on 90% confidence limit.

We estimate that inside the housing, temperature will be 15°C higher than the ambient temperature. Therefore, the MTBF calculation refers to an ambient temperature of 45°C. The humidity is limited to 60%.

Draco tera 576 chassis	50,000 POH
Draco tera 576S chassis	72,000 POH
Draco tera 288 chassis	260,000 POH
Draco tera 160/152 chassis	310,000 POH
Draco tera 80 chassis	320,000 POH
Draco tera 48 chassis	350,000 POH
CPU board	480,000 POH
I/O board SFP	500,000 POH
I/O board Cat X	410,000 POH
Draco tera 576/576S PSU	500,000 POH
Draco tera 288/160/152 PSU	200,000 POH
Draco tera 80/48 PSU	130,000 POH

8 Maintenance

The Draco tera contains various components and assemblies that can be maintained. All relevant components and assemblies are hot swappable and can be removed and exchanged during operation.

The following exchangeable components can be found within the Draco tera:

8.1 Power Supply Units

In order to exchange the power supply units, proceed as follows:

1. Make sure that the power cord cable is removed from the power supply that has to be exchanged.
2. Unlock the locking screw(s).
3. With the power supply units of Draco tera 288, 160 and 152, turn the unlocked bracket down.
4. Pull the power supply unit out of the corresponding slot.
5. Push a new or maintained power supply unit into the slot and lock it accordingly.
6. Connect the power cord cable to the power supply unit. It will be recognized by the system and can be used afterwards.

8.2 Fan trays

In order to exchange the fan trays, proceed as follows:

1. Unlock the locking screw(s).
2. Pull the fan tray out of the corresponding slot by using the provided mount.
3. Push a new or maintained fan tray into the slot.
4. Lock the fan tray accordingly. It will be recognized by the system and can be used afterwards.

8.3 CPU Board

In order to exchange the CPU board, proceed as follows:

1. Pull the locking pin slowly out of the CPU board up to the stop.
Wait until the CPU board is deregistered from the matrix. The de-registration will be confirmed by a permanent green light of the status LED #1 on the CPU board (see Chapter 3.7.1, Page 23).
2. Remove all cables from the CPU board.
3. Pull the CPU board out of the corresponding slot by using the locking pin.
4. Push a new or maintained CPU board into the slot and lock it accordingly.
A successful registration of the CPU board will be shown by a permanent green flashing of status LED #1.
5. Connect all cables to the CPU board according to the exchanged board.



When exchanging a CPU board the new one will automatically receive the current matrix configuration. During CPU board exchange the Draco tera should not be switched off.

8.4 I/O-Board

In order to exchange a I/O board, proceed as follows:

1. Pull the locking pin slowly out of the I/O board up to the stop.
Wait until the I/O board is deregistered from the matrix. The deregistration will be confirmed by a permanent green light of the status LED #1 on the CPU board (see Chapter 3.7.1, Page 23).
2. Remove all cables from the I/O board.
3. Pull the I/O board out of the corresponding slot by using the locking pin.
4. Push a new or maintained CPU board into the slot and lock it accordingly.
A successful registration of the CPU board will be shown by a permanent green flashing of status LED #1.
5. Connect all cables to the I/O board according to the exchanged board.



For a 24/7 operation it is recommended that a stock of critical spare parts is maintained, including a chassis.

8.5 Filter Pads

Filter pads should be checked regularly for accumulated dust and cleaned with low pressure compressed air or suction.

The inspection cycle depends on the ambient air and cannot be determined generally, but a period of 6 months should not be exceeded.

Filter pads or filter trays should be replaced at regular intervals not exceeding one year.

In order to replace a filter pad, proceed as follows:

1. Pull the filter pad together with the mounting frame out of the proper slot by using the handle.
2. Press the used filter pad out of the proper mounting frame.
3. Insert a new filter pad into the mounting frame.
4. Replace the mounting frame in the slot.

9 Troubleshooting

In the following chapters, support for problems with the Draco tera matrix is provided. It is assumed that fully operational CPU and CON Devices are available, which can be tested over a peer-to-peer connection using Cat X or fibre cables. Please refer to the relevant manuals for assistance with this if necessary.

9.1 External Failure

Diagnosis	Possible Reason	Measure
Matrix cannot be started anymore.	Fuse at the standard appliance outlet.	➔ Check fuse.

9.2 Video Interference

Diagnosis	Possible Reason	Measure
Opening the OSD not possible	No OSD jumper set	➔ Set jumper 11 on the CON unit.
Incorrect video display	Cable connection disturbed	➔ Check the connection, length and quality of the interconnect cable to the units.

9.3 Malfunction of Fans

Diagnosis	Possible Reason	Measure
Fans only run under full load	Communication to fan tray is not working	➔ Remove and reinstall fan tray. ➔ Swap both fan trays to the other slot. ➔ Restart the matrix.
Fans do not run, LED OK on	Fans defective	➔ Contact your dealer.
Fans do not run, LED OK off	Power supply	➔ Check power supply and power connection.

9.4 Malfunction of Power Supply Units

Diagnosis	Possible Reason	Measure
Matrix cannot be started	Power supply units not locked correctly	➔ Check lock and plug-in of the power supply units.
	No power supply available	➔ Check if power supply cables are connected correctly.
	Power supply units are not switched on	➔ Check switch on the power supply units.

9.5 Network Error

Diagnosis	Possible Reason	Measure
Network settings are not assumed after editing.	Restart of the matrix not yet completed.	➔ Restart the matrix.

9.6 Failure at the Matrix

Diagnosis	Possible Reason	Measure
Serial control impossible or only restrictedly possible.	CPU and matrix operating at different Baud rates.	➔ Change Baud rate in the matrix and CPU (see Chapter 5.3.2, Page 80).
Serial control via RJ45 port not possible.	Wrong network cable.	➔ Use a crossed network cable.
Port definitions as USB 2.0 invalid.	Restart of the matrix not yet completed.	➔ Restart the matrix.

9.7 Blank Screen

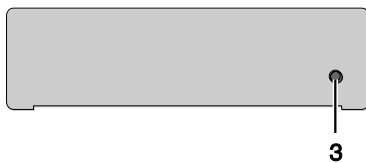
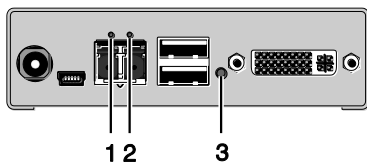
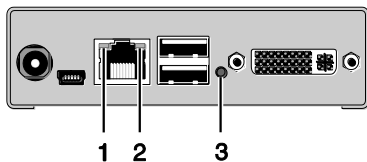

Rear View

Front View

Diagnosis	Possible Reason	Measure
Monitors remains dark after switching operation	Switching to a CPU Port without active Source (computer, CPU).	➔ Switching to a CPU Port with an active source (computer, CPU).
	Connection of a console with a CON port or connection of a CPU to a CPU port not established correctly.	➔ Check CON and CPU port connections on the matrix.
LED 1 on or LED 2 off	Connections CON unit, matrix and CPU unit.	➔ Check connecting cables and connectors. (No cable, cable break, CPU/CON unit offline, CPU/CON unit connected to the wrong port)
LED 3 off	Power supply	➔ Check power supply units and the connection to the power network.

10 Technical Support

Prior to contacting support please ensure you have read this manual, and then installed and set-up your Draco tera as recommended.

10.1 Support Checklist

To efficiently handle your request it is necessary that you complete a support request checklist ([Download](#)). Please ensure that you have the following information available before you call:

- Company, name, phone number and email
- Type and serial number of the device (see bottom of device)
- Date and number of sales receipt, name of dealer if necessary
- Issue date of the existing manual
- Nature, circumstances and duration of the problem
- Components included in the system (such as graphic source/CPU, OS, graphic card, monitor, USB-HID/USB 2.0 devices, interconnect cable) including manufacturer and model number
- Results from any testing you have done

10.2 Shipping Checklist

1. To return your device, contact your dealer to obtain a RMA number (Return-Material-Authorization).
2. Package your devices carefully, preferably using the original box. Add all pieces which you received originally.
3. Note your RMA number visibly on your shipment.



Devices that are sent in without a RMA number cannot be accepted. The shipment will be sent back without being opened, postage unpaid.

11 Certificates/Directives

11.1 North American Regulatory Compliance

This equipment has been found to comply with the limits for a Class A digital device, pursuant to Part 15 of the FCC Rules. These limits are designed to provide reasonable protection against harmful interference when the equipment is operated in a commercial environment. This equipment generates, uses, and can radiate radio frequency energy and, if not installed and used in accordance with the instruction manual, may cause harmful interference to radio communications. Operation of this equipment in a residential area is likely to cause harmful interference in which case the user will be required to correct the interference at his own expense.

Changes or modifications not expressly approved by the party responsible for compliance could void the user's authority to operate the equipment.

Shielded cables must be used with this equipment to maintain compliance with radio frequency energy emission regulations and ensure a suitably high level of immunity to electromagnetic disturbances.

All power supplies are certified to the relevant major international safety standards.

11.2 Product Safety

The product safety of the devices is proven by the compliance to the following standards:

- IEC 60950-1/A1:2010
- EN 60950-1/A12:2011/A1:2010/A11:2009
- UL 60950-1-2007
- CAN/CSA-C22.2 60950-1-07

The compliance is verified and confirmed by TÜV Süd, Germany.



11.3 WEEE

The manufacturer complies with the EU Directive 2012/19/EU on the prevention of waste electrical and electronic equipment (WEEE).

The device labels carry a respective marking.

11.4 RoHS

This device complies with the Directive 2011/65/EU of the European Parliament and of the council of 8 June 2011 on the restriction of the use of certain hazardous substances in electrical and electronic equipment (including the Commission Delegated Directive (EU) 2015/853 of 31 March 2015 amending Annex II to Directive 2011/65/EU).

The device labels carry a respective marking.

12 EU Declaration of Conformity

The products listed below in the form as delivered comply with the provisions of the following European Directives:

- 2014/30/EU Council Directive on the approximation of the laws of the Member States relating to electromagnetic compatibility
- 2014/35/EU Council Directive on the harmonization of the laws of the Member States relating to the making available on the market of electrical equipment designed for use within certain voltage limits
- 2011/65/EU Council Directive on the restriction of the use of certain hazardous substances in electrical and electronic equipment.

Product list: 480 Series

The products comply with the following harmonized standards for Information Technology Equipment:

- EN 55032:2015
- EN 55024:2010 + A1:2015
- EN 61000-3-2:2019
- EN 61000-3-3:2013
- EN 61000-6-2:2019
- EN 60950-1:2006/A2:2013

Manufacturer:

IHSE GmbH
Benzstrasse 1
88094 Oberteuringen
Deutschland

Oberteuringen, February 26, 2020

Managing Director, Dr. Enno Littmann



This declaration certifies the conformity to the specified directives but contains no assurance of properties.

13 Glossary

The following terms are commonly used in this guide or in video and KVM technology:

Term	Explanation
AES/EBU	Digital audio standard that is officially known as AES3 and that is used for carrying digital audio signals between devices.
Cat X	Any Cat 5e (Cat 6, Cat 7) cable
CGA	Color Graphics Adapter (CGA) is an old analog graphic standard with up to 16 displayable colors and a maximum resolution of 640x400 pixels.
Component Video	Component Video (YPbPr) is a high-quality video standard that consists of three independently and separately transmittable video signals, the luminance signal and two color difference signals.
Composite Video	Composite Video is also called CVBS and it is part of the PAL TV standard.
CON Unit	Component of a KVM Extender or Media Extender to connect to the console (monitor(s), keyboard and mouse; optionally also with USB 2.0 devices)
Console	Keyboard, mouse and monitor
CPU Unit	Component of a KVM Extender or Media Extender to connect to a source (computer, CPU)
CVBS	The analog color video baseband signal (CVBS) is also called Composite Video and it is part of the PAL TV standard.
DDC	Display Data Channel (DDC) is a serial communication interface between monitor and source (computer, CPU). It allows a data exchange via monitor cable and an automatic installation and configuration of a monitor driver by the operating system.
DisplayPort	A VESA standardised interface for an all-digital transmission of audio and video data. It is differentiated between the DisplayPort standards 1.1 and 1.2. The signals have LVDS level.
Dual Access	A system to operate a source (computer, CPU) from two consoles

Term	Explanation
Dual Link	A DVI-D interface for resolutions up to 2560x2048 by signal transmission of up to 330 MPixel/s (24-bit)
Dual-Head	A system with two video connections
DVI	Digital video standard, introduced by the Digital Display Working Group (http://www.ddwg.org). Single Link and Dual Link standard are distinguished. The signals have TMDS level.
DVI-I	A combined signal (digital and analog) that allows running a VGA monitor at a DVI-I port – in contrast to DVI-D (see DVI).
EGA	The Enhanced Graphics Adapter (EGA) is an old analog graphic standard, introduced by IBM in 1984. A D-Sub 9 connector is used for connection.
Fiber	Single-mode or multi-mode fiber cables
HDMI	An interface for an all-digital transmission of audio and video data. It is differentiated between the HDMI standards 1.0 to 1.4a. The signals have TMDS level.
KVM	Keyboard, video and mouse
Mini-XLR	Industrial standard for electrical plug connections (3 pole) for the transmission of digital audio and control signals
Multi-mode	62.5µ multi-mode fiber cable or 50µ multi-mode fiber cable
OSD	The On-Screen-Display is used to display information or to operate a device.
Quad-Head	A system with four video connections
RCA (Cinch)	A non-standard plug connection for transmission of electrical audio and video signals, especially with coaxial cables
S/PDIF	A digital audio interconnect that is used in consumer audio equipment over relatively short distances.
SFP	SFPs (Small Form Factor Pluggable) are pluggable interface modules for Gigabit connections. SFP modules are available for Cat X and fiber interconnect cables.

Term	Explanation
Single Link	A DVI-D interface for resolutions up to 1920x1200 by signal transmission of up to 165 MPixel/s (24-bit). Alternative frequencies are Full HD (1080p), 2K HD (2048x1080) and 2048x1152.
Single-Head	A system with one video connection
Single-mode	9 μ single-mode fiber cable
S-Video (Y/C)	S-Video (Y/C) is a video format transmitting luminance and chrominance signals separately. Thereby it has a higher quality standard than CVBS.
TOSLINK	Standardized fiber connection system for digital transmission of audio signals (F05 plug connection)
Triple-Head	A system with three video connections
USB-HID	USB-HID devices (Human Interface Device) allow for data input. There is no need for a special driver during installation; "New USB-HID device found" is reported. Typical HID devices include keyboards, mice, graphics tablets and touch screens. Storage, video and audio devices are not HID.
VGA	Video Graphics Array (VGA) is a computer graphics standard with a typical resolution of 640x480 pixels and up to 262,144 colors. It can be seen as a follower of the graphics standards MDA, CGA and EGA.

13.1 Matrix specific Glossary

Term	Explanation
Auto Disconnect	Matrix function that allows an automatic disconnect between a console and a CPU, if OSD is opened via this console.
Auto Logout	Matrix function that describes the duration of inactivity after the user has been logged out from the OSD at this console.
CON Device	Logical term that summarizes several physical extenders to switch more complex console systems via matrix.
CON Timeout	Matrix function that allows an automatic disconnect of the own console from the connected CPU after a predefined time.
Console ACL	Console Access Control List is a list that shows the respective switching rights for the various consoles.
CPU Auto Connect	Matrix function that allows an automatic connection establishment between the own console and a random CPU that is available.
CPU Device	Logical term that summarizes several physical extenders to switch more complex CPU systems via matrix.
CPU Timeout	Matrix function that allows the user to disconnect after a predefined period of time of inactivity from the respective CPU.
EXT Unit	Part or extender board of a CON or CPU unit with a connection to the matrix. A CON or CPU unit can consist of several EXT devices.
Force Connect	Matrix function that allows to switch with the own console to a CPU that is already used and in doing so to take keyboard and mouse control. The connected console so far loses K/M control, but keeps video control.
Force Disconnect	Matrix function that allows to switch with the own console to a CPU that is already used and in doing so to take KVM control. The connected console so far loses complete KVM control.
Java Tool	Java based control and configuration tool for the Draco tera matrix.

Term	Explanation
Keyboard Connect	Matrix function that allows taking over the keyboard control of an inactive console.
Macro Keys	Programmable keys that can execute a stringing together of commands to the matrix.
Mouse Connect	Matrix function that allows taking the mouse control of an inactive console.
Non-Blocking-Access	Matrix configuration where no user can be disturbed by an activity of another user.
OSD Timeout	Matrix function that closes the OSD automatically after a predefined period of time of inactivity.
Release Time	Matrix function that allows a console that is connected with the same CPU to release the K/M control after a predefined time.
Service Mode	Defined maintenance condition that allows updating of extenders that are connected to the matrix.
Tie Line	Communication connection to and between extension modules in a network environment.
User ACL	User Access Control List is a list that shows the respective switching rights for the various users.
Video Sharing	Matrix function that allows switching from the user's console to any CPU with video.